

HI98494

Multiparameter
Bluetooth®

Portable pH / EC / opdo® Meter



INSTRUCTION MANUAL

Dear
Customer,

Thank you for choosing a Hanna Instruments product.

Please read this instruction manual carefully before using this instrument.

This manual will provide you with the necessary information for correct use of this instrument, as well as a precise idea of its versatility.

If you need additional technical information, do not hesitate to e-mail us at tech@hannainst.com or view our contact list at www.hannainst.com.

All rights are reserved. Reproduction in whole or in part is prohibited without the written consent of the copyright owner, Hanna Instruments Inc., Woonsocket, Rhode Island, 02895, USA.

TABLE OF CONTENTS

1. PRELIMINARY EXAMINATION	5
2. GENERAL DESCRIPTION & INTENDED USE.....	6
3. SPECIFICATIONS.....	7
3.1. METER SPECIFICATIONS	7
3.2. PROBE SPECIFICATIONS	10
3.3. SENSOR SPECIFICATIONS	10
4. FUNCTIONAL & KEYPAD DESCRIPTION	12
5. SENSOR PREPARATION & INSTALLATION	14
5.1. SENSOR TYPES & DESCRIPTIONS	14
5.2. SENSOR PREPARATION & CONDITIONING	15
5.3. SENSOR INSTALLATION	16
5.4. SENSOR MAINTENANCE.....	18
6. GENERAL OPERATIONS.....	20
6.1. BATTERY CAPACITY & REPLACEMENT.....	20
6.2. CONNECTING THE PROBE.....	21
6.3. TURNING THE METER ON.....	21
6.4. TUTORIAL.....	22
6.5. BASIC OPERATIONS.....	22
6.6. HELP	23
6.7. FUNCTIONAL DIAGRAM OF THE INSTRUMENT	23
7. PARAMETER SETUP.....	24
7.1. PARAMETER SELECTION	24
7.2. PARAMETER UNITS	24
7.3. PARAMETER COEFFICIENTS	27
7.4. AVERAGING.....	28
8. CALIBRATION	29
8.1. QUICK CALIBRATION.....	30
8.2. pH CALIBRATION.....	31
8.3. ORP CALIBRATION.....	34
8.4. DISSOLVED OXYGEN CALIBRATION.....	35
8.5. CONDUCTIVITY CALIBRATION.....	38
8.6. TEMPERATURE CALIBRATION	42
8.7. PRESSURE CALIBRATION	43

9. SYSTEM SETUP..... 45

 9.1. METER SETUP..... 45

 9.2. PROBE SETUP..... 50

10. BLUETOOTH® 51

11. STATUS 52

 11.1. METER STATUS..... 52

 11.2. PROBE STATUS..... 52

 11.3. GLP..... 53

12. MEASUREMENT..... 55

13. LOGGING..... 56

 13.1. ONE SAMPLE ON METER..... 57

 13.2. START METER LOG..... 57

 13.3. LOG RECALL..... 58

 13.4. LOG NOTES 61

 13.5. PC CONNECTION 61

14. PROBE DEPLOYMENT 62

15. TROUBLESHOOTING & ERROR MESSAGES..... 64

16. ACCESSORIES..... 66

CERTIFICATION 69

RECOMMENDATIONS FOR USERS..... 69

WARRANTY 70

1. PRELIMINARY EXAMINATION

Remove the instrument and accessories from the packaging and examine it carefully. For further assistance, please contact your local Hanna Instruments Office or email us at tech@hannainst.com.

Each [HI98494](#) is delivered in a rugged carrying case and is supplied with:

- [HI7698494](#) Multi-sensor probe
- [HI7698194-1](#) pH/ORP sensor
- [HI7698194-3](#) EC/TDS/Resistivity/Salinity sensor
- [HI7698494-5](#) Optical DO sensor
- [HI764113-1](#) DO Smart Cap with o-ring
- [HI7698295](#) Short protective probe shield
- [HI7698290](#) Calibration beaker
- [HI9828-20](#) Quick calibration standard solution (230 mL)
- [HI7040](#) Zero oxygen solution set (120 mL)
- [HI76984942](#) Probe maintenance kit
- [HI920016](#) USB cable
- 1.5V AA alkaline batteries (4 pcs.)
- Instrument quality certificate
- Probe quality certificate
- DO Smart Cap quality certificate
- Instruction manual

Note: *Save all packing material until you are sure that the instrument works correctly. Any damaged or defective item must be returned in its original packing material with the supplied accessories.*

2. GENERAL DESCRIPTION & INTENDED USE

HI98494 is a portable logging multiparameter system (meter and probe) that monitors up to 13 different water quality parameters (6 measured and 7 calculated) such as pH, ORP, conductivity, dissolved oxygen and temperature. The **HI98494** features a graphic, backlit display that automatically sizes the digits to fit the screen with on-screen graphing capability. Each parameter is fully configurable.

The **HI7698494** microprocessor-based intelligent multisensor probe uses a **HI7698194-1** sensor for pH and ORP measurements, the **HI7698194-3** sensor for conductivity and associated parameters, and a **HI7698494-5** Optical DO sensor with **HI764113-1** DO Smart Cap for measurements of dissolved oxygen. The Optical DO sensor provides accurate DO measurements over long periods of time without the need for frequent calibration. The probe also has a built in temperature sensor and a removable protective shield.

The **HI98494** system is easy to setup and use. It has a built-in tutorial mode to guide users step-by-step through sensor preparation, installation, maintenance and calibration processes.

The meter utilizes a dual charging system, utilizing a rechargeable Li battery and backup alkaline batteries to extend field use.

The meter can log data that can be easily downloaded as a CSV file or graph using Bluetooth® wireless technology to Hanna Lab on iOS and Android devices or to a PC using a USB type A to C cable.

The **HI98494** meter was designed to withstand harsh environmental conditions and is ideal for field measurements. The meter meets IP67 standard (30 minute immersion at a depth of 1 m) and the multi-sensor probe is totally sealed against water and dust, and meets IP68 standard (continuous immersion in water).

Main Features

- Rugged, water-resistant meter and waterproof probe
- Monitors up to 13 different water quality parameters
- Graphical display of logged data on backlit LCD screen
- Log-on-demand and automatic logging on meter for all parameters
- Download log files to Hanna Lab using Bluetooth wireless technology or to a PC using USB-C cable
- Field-replaceable sensors with color coded caps and auto recognition including Optical DO technology
- Built-in barometer for DO concentration compensation
- Tutorial mode that guides user step-by-step
- USB-C interface for PC communication
- Dual battery system for extended field use
- Good Laboratory Practice feature, the last 5 calibrations are automatically stored

3. SPECIFICATIONS

3.1. METER SPECIFICATIONS

pH / mV	Range	0.00 to 14.00 pH* ± 600.0 mV
	Resolution	0.01 pH 0.1 mV
	Accuracy	± 0.02 pH ± 0.5 mV
	Calibration	One point, using HI9828-25 Quick calibration solution Up to three points using five standard buffers (pH 4.01, 6.86, 7.01, 9.18, 10.01) and one custom buffer
ORP	Range	± 2000.0 mV
	Resolution	0.1 mV
	Accuracy	± 1.0 mV
	Calibration	One point (relative mV)
Dissolved Oxygen (DO)	Range	0.00 to 50.00 mg/L 0.0 to 500.0 % saturation
	Resolution	0.01 mg/L 0.1 % saturation
	Accuracy	± 1.5 % of reading ± 0.01 mg/L from 0.00 to 20.00 mg/L ± 5 % of reading from 20.00 to 50.00 mg/L ± 1.5 % of reading ± 0.1 % from 0.0 to 200.0 % saturation ± 5 % of reading from 200.0 to 500.0 % saturation
	Calibration	One point, quick calibration in water-saturated air One or two points, at 100 % and 0 % One point, using a custom solution (% saturation or mg/L)
Altitude Compensation, automatic: 420 to 850 mmHg		
*The range may be limited by the sensor's limits.		

Conductivity	Range	0 to 200 mS/cm 0 to 400 mS/cm (absolute)	
	Resolution	Manual	1 μ S/cm; 0.001 mS/cm; 0.01 mS/cm; 0.1 mS/cm; 1 mS/cm
		Automatic	1 μ S/cm from 0 to 9999 μ S/cm 0.01 mS/cm from 10.00 to 99.99 mS/cm 0.1 mS/cm from 100.0 to 400.0 mS/cm
		Automatic (mS/cm)	0.001 mS/cm from 0.000 to 9.999 mS/cm 0.01 mS/cm from 10.00 to 99.99 mS/cm 0.1 mS/cm from 100.0 to 400.0 mS/cm
	Accuracy	± 1 % of reading or ± 1 μ S/cm, whichever is greater	
	Calibration	One point, using HI9828-25 Quick calibration solution One point, using six standard solutions (84 μ S/cm, 1413 μ S/cm, 5.00 mS/cm, 12.88 mS/cm, 80.0 mS/cm, 111.8 mS/cm) or custom point	
Resistivity	Range	0 to 999999 Ω -cm	
	Resolution	1 Ω -cm; 0.1 k Ω -cm; 0.0001 M Ω -cm	
	Calibration	Based on conductivity or salinity calibration	
Total Dissolved Solids (TDS)	Range	0 to 400000 ppm (mg/L) (the maximum value depends on the TDS factor)	
	Resolution	Manual	1 ppm (mg/L); 0.001 ppt (g/L); 0.01 ppt (g/L); 0.1 ppt (g/L); 1 ppt (g/L)
		Automatic	1 ppm (mg/L) from 0 to 9999 ppm (mg/L) 0.01 ppt (g/L) from 10.00 to 99.99 ppt (g/L) 0.1 ppt (g/L) from 100.0 to 400.0 ppt (g/L)
		Automatic: ppt (g/L)	0.001 ppt (g/L) from 0.000 to 9.999 ppt (g/L) 0.01 ppt (g/L) from 10.00 to 99.99 ppt (g/L) 0.1 ppt (g/L) from 100.0 to 400.0 ppt (g/L)
	Accuracy	± 1 % of reading or ± 1 ppm (mg/L), whichever is greater	
	Calibration	Based on conductivity calibration	
Salinity	Range	0.00 to 70.00 PSU	
	Resolution	0.01 PSU	
	Accuracy	± 2 % of reading or ± 0.01 PSU, whichever is greater	
	Calibration	One point, using a custom solution	

Seawater Sigma	Range	0.0 to 50.0 σ_t , σ_0 , σ_{15}
	Resolution	0.1 σ_t , σ_0 , σ_{15}
	Accuracy	± 1.0 σ_t , σ_0 , σ_{15}
	Calibration	Based on conductivity or salinity calibration
Atmospheric Pressure	Range	450.0 to 850.0 mmHg
		17.72 to 33.46 inHg
		600.0 to 1133.2 mbar
		8.702 to 16.436 psi
		0.5921 to 1.1184 atm
	60.00 to 113.32 kPa	
Resolution	0.1 mmHg; 0.01 in Hg; 0.1 mbar 0.001 psi; 0.0001 atm; 0.01 kPa	
Accuracy	± 3.0 mmHg within $\pm 15^\circ\text{C}$ from calibration temperature	
Calibration	One point using a custom value	
Temperature	Range	-5.00 to 50.00 $^\circ\text{C}$
		23.00 to 122.00 $^\circ\text{F}$
		268.15 to 323.15 K
	Resolution	0.01 $^\circ\text{C}$; 0.01 $^\circ\text{F}$; 0.01 K
Accuracy	± 0.15 $^\circ\text{C}$; ± 0.27 $^\circ\text{F}$; ± 0.15 K	
Calibration	One point using a custom value	
Temperature Compensation	Automatic from -5 to 50 $^\circ\text{C}$ (23 to 122 $^\circ\text{F}$)	
Logging Memory	50000 records, interval logging 20000 records, log-on-demand of all parameters	
Logging Interval	1 second to 3 hours	
USB-C (Host) Functions	Mass-storage host	
USB-C (Device) Functions	Mass-storage device	
Protection Rating	IP67	
Environment	0 to 50 $^\circ\text{C}$ (32 to 122 $^\circ\text{F}$); RH 100 %	
Battery Type	4 x 1.5 V AA alkaline batteries and 1x internal Li-ion rechargeable battery	
Battery Life	Minimum 200 hours (AA batteries, without backlighting and Bluetooth [®]) Minimum 50 hours (Li-ion battery, without backlighting and Bluetooth [®])	
Dimensions	185 x 93 x 35.2 mm (7.3 x 3.6 x 1.4")	
Weight (with batteries)	435 g (13.3 oz)	

3.2. PROBE SPECIFICATIONS

Sensor Inputs	3	
Sample Environment	Fresh, Brackish, Seawater	
Protection Rating	IP68	
Operating Temperature	-5 to 50 °C (23.0 to 122.0 °F)	
Storage Temperature	-20 to 70 °C (-4.0 to 158.0 °F)	
Maximum Depth	20 m (66')	
Dimensions (without cable)	Length 342 mm (13.5") Diameter 46 mm (1.8")	
Weight (with sensors)	570 g (20.1 oz.)	
Cable Specification	Multistrand-multiconductor shielded cable with internal strength member rated for 68 kg (150 lb) intermittent use	
Wetted Materials	Body	ABS
	Threads	Nylon
	Shield	ABS and 316 Stainless Steel
	Temperature probe	316 Stainless Steel
	O-rings	EPDM

3.3. SENSOR SPECIFICATIONS

HI7698194-0 pH	Measurement Unit	pH, mV (pH)	
	Measure Range	0.00 to 13.00 pH ± 600.0 mV (pH)	
	Color Code	Red	
	Temperature Range	-5 to 55 °C (23.0 to 131.0 °F)	
	Materials	Tip	pH glass
		Junction	Wick
		Body	PEI
		Electrolyte	Gel
	Maintenance Solution	HI70300 Storage solution	
	Reference	Double junction	
	Immersion Depth	20 m (65')	
Dimensions	Length	118 mm (4.6")	
	Diameter	15 mm (0.6")	

HI7698194-1 pH/ORP	Measurement Unit	pH, mV (pH), mV (ORP)		
	Measure Range	0.00 to 13.00 pH		
		\pm 600.0 mV (pH)		
		\pm 2000.0 mV (ORP)		
	Color Code	Red		
	Temperature Range	-5 to 55 °C (23.0 to 131.0 °F)		
	Materials	Tip	pH glass and platinum ORP	
		Junction	Wick	
		Body	PEI	
		Electrolyte	Gel	
Maintenance Solution	HI70300 Storage solution			
Reference	Double junction			
Immersion Depth	20 m (65')			
Dimensions	Length	118 mm (4.6")		
	Diameter	15 mm (0.6")		
HI7698194-3 EC	Measurement Unit	μ S/cm, mS/cm		
	Measure Range	0.0 to 200.0 mS/cm		
		0.0 to 400 mS/cm (absolute)		
	Color Code	Blue		
	Temperature Range	-5 to 55 °C (23.0 to 131.0 °F)		
	Materials	Electrodes	Stainless Steel (AISI 316)	
		Body	ABS and Epoxy	
	Immersion Depth	20 m (65')		
	Dimensions	Length	111 mm (4.4")	
		Diameter	17 mm (0.7")	
HI7698494-5 Dissolved Oxygen	Measurement Unit	% saturation, mg/L		
	Measure Range	0.0 to 500.0 % saturation		
		0.00 to 50.00 mg/L		
	Color Code	Green		
	Temperature Range	-5 to 50 °C (23.0 to 122.0 °F)		
	Sensor Type	Optical		
	Immersion Depth	20 m (65')		
	Dimensions	Length	99 mm (3.9")	
Diameter		17 mm (0.7")		

4. FUNCTIONAL & KEYPAD DESCRIPTION

Front View

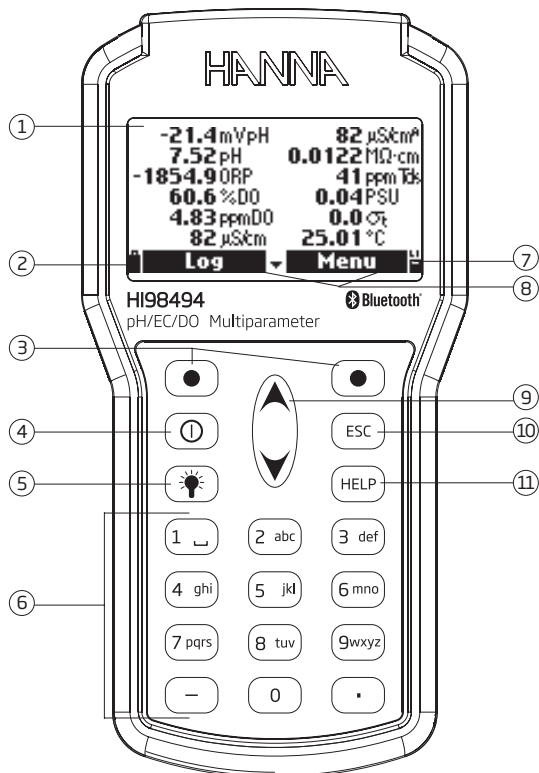

1. Liquid Crystal Display (LCD)
2. Alkaline battery level indicator
3. Functional keys, press to perform the function displayed above them on the screen
4. Power (On / Off) key, press to turn the meter on and off
5. Lamp key, press to turn the backlight on and off
6. Alphanumeric keypad, press to insert alphanumeric codes
7. Rechargeable battery level indicator
8. Soft key functions defined on display
9. Arrow keys, scroll the displayed options and messages
10. ESC key, press to return to the previous screen
11. HELP key, press to display the context sensitive help menu

Top View

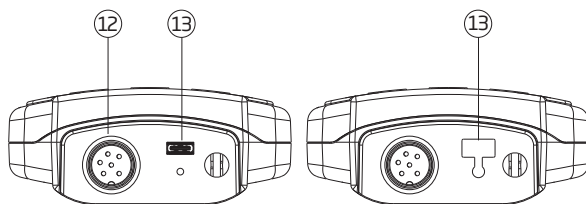

- 12. DIN connector for probe connection
- 13. USB-C connector with protective cap

HI7698494 multisensor probe

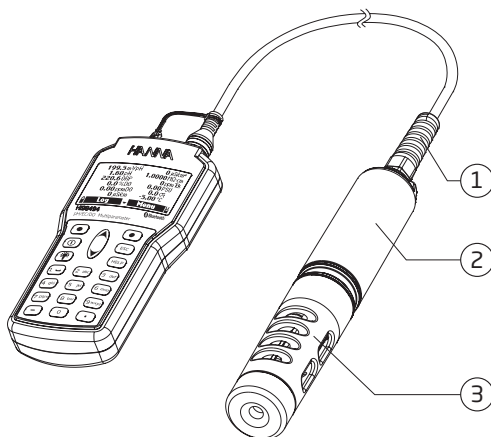

- 1. Strain relief
- 2. Sensor body
- 3. Protective shield

5. SENSOR PREPARATION & INSTALLATION

5.1. SENSOR TYPES & DESCRIPTIONS

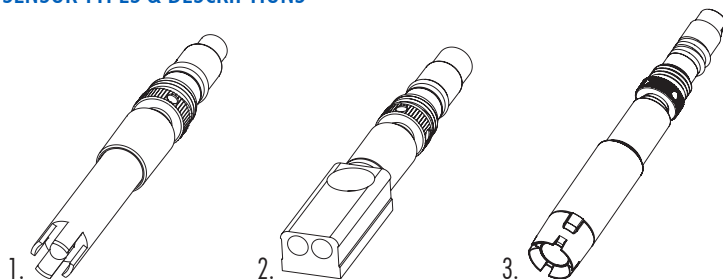

1. **HI7698194-0** combination pH sensor features a plastic body pH sensor with a glass bulb and a silver/silver chloride double junction reference with gelled electrolyte. **HI7698194-1** combination pH / ORP sensor features a plastic body pH sensor with a glass bulb, a platinum sensor for redox measurements and a silver/silver chloride double junction reference with gelled KCl electrolyte.
2. **HI7698194-3** four electrode conductivity (EC / TDS / Resistivity / Salinity) sensor, immune to polarization or surface coatings.
3. **HI7698494-5** optical dissolved oxygen (opdo[®]) sensor is based on the principle of fluorescence quenching. An immobilized Pt based luminophore is excited by the light of a blue LED and emits a red light. As oxygen interacts with the luminophore it reduces the intensity and lifetime of the luminescence. The lifetime of the luminescence is measured by a photodetector and is used to calculate the dissolved oxygen concentration.

Smart Cap Description

Easy to use Smart Caps contain pre-loaded calibration coefficients that are automatically transmitted to the probe. The Smart Cap stores data in a RFID tag. If caps are switched between probes, no information will be lost. See section 5.2. SENSOR PREPARATION & CONDITIONING for Smart Cap installation procedure.

The Smart Cap™ is locked in place on the optical probe and includes the immobilized O₂ sensitive luminophore with rugged insoluble black oxygen permeable protective layer.

Over time, the sensor's optical components can age but are compensated for by using the reference signal to compensate the measuring path. As a result, the sensor provides accurate DO measurements over long periods of time without the need for frequent calibration.

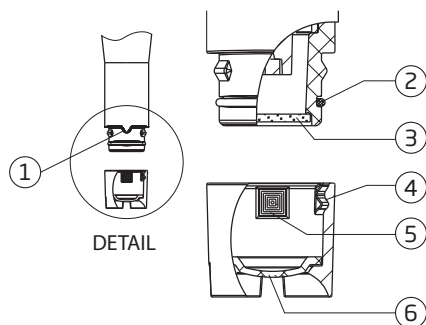

1	Alignment key	4	Smart Cap™
2	O-Ring Seal	5	RFID Tag
3	Optical window	6	Embedded O ₂ sensitive luminophore with black protective layer

5.2. SENSOR PREPARATION & CONDITIONING

pH/ORP Combination Sensor or pH Sensor

To prepare for installation:

1. Remove the shipping cap from the pH sensor.
2. If the shipping cap does not contain any liquid, pour [HI70300](#) Storage solution into the shipping cap.
3. Place it back on the sensor and soak for at least 30 minutes before use. If [HI70300](#) Storage solution is not available, pH 4.01 buffer may be used.

DO Sensor

To prepare for installation:

1. Sparingly lubricate the o-ring with a thin film of silicone grease. Use care to prevent grease from contacting the optical window.
2. Remove the [HI764113-1](#) Smart Cap from the container.
3. Align the cutout arrow on the Smart Cap with the matching guide on the [HI7698494-5](#) sensor body.
4. Slide and press the Smart Cap onto the sensor body until the cap snaps in place. Once the cap is installed, it should not be removed unless a new cap is required.
5. Place the sensor in purified water to hydrate the Smart Cap before use.

To replace the Smart Cap:

1. Remove the expired Smart Cap from the sensor by squeezing the cap at the cutout arrow and pulling it off the sensor body (do not twist).
2. Remove the used o-ring by rolling it off the sensor.
3. Clean the o-ring groove and lens with a soft tissue followed by the lens cleaning wipe.
4. Remove the new o-ring from the replacement cap kit and slide on the sensor body (do not roll or twist the o-ring).
5. Remove the syringe plunger, cut the top off supplied sachet with silicone grease and empty contents into the syringe. Using the syringe, sparingly lubricate the o-ring with a thin film of the supplied grease. Avoid getting grease or fingerprints onto the optical window. Do not substitute other grease or lubricants as it may cause the o-ring to swell.
6. Remove the new optical cap from the replacement cap kit. Align the cutout arrow on the Smart Cap with the matching guide on the sensor body.
7. Slide and press the Smart Cap onto the sensor body until the cap snaps in place. Once the cap is installed, it should not be removed unless a new cap is required.
8. Place the sensor in purified water to hydrate the Smart Cap before use.

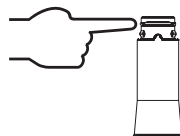
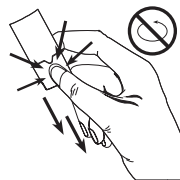

EC Sensor

The EC sensor does not need to be soaked or hydrated before use. See section 5.4. SENSOR MAINTENANCE if required.

5.3. SENSOR INSTALLATION

To make installation easier, the sensors have color-coded caps, and the sockets are identified with colored triangles, corresponding to the colors of the sensors (pH - red; EC - blue; DO - green).

The [HI7698494](#) probe sensor connector sockets identified with color-coded triangles are:

- Connector 1 (red): pH or pH / ORP sensor
- Connector 2 (green): DO sensor
- Connector 3 (blue): EC sensor

To install the sensors follow the steps below:

1. Remove the protective shield from the probe and set aside.
2. Cut top off supplied sachet with silicone grease and sparingly lubricate the o-ring with a thin film of the grease. Do not substitute other grease or lubricants as it may cause the o-ring to swell.

3. Insert the sensor into the correctly color-coded opening while positioning the connector key toward the center of the probe. Make sure the connector is seated correctly (the sensor will no longer move freely) before tightening the locking threads with your fingers.
4. Continue to tighten the locking thread with the small hex key supplied in the maintenance kit until the sensor is secured tightly against the probe body.
5. All sensors have to be conditioned and calibrated before use.
6. Screw the protective shield onto the probe body, to protect the sensors.

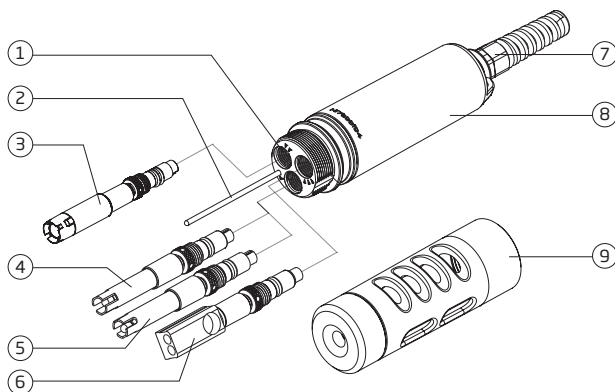

1	Sensor sockets	6	EC / TDS / Resistivity / Salinity sensor
2	Temperature sensor	7	Strain relief
3	opdo [®] sensor	8	Sensor body
4	pH sensor	9	Protective shield
5	pH / ORP combination sensor		

Note: To maintain a waterproof probe, if a sensor is not installed a plug must be inserted.

5.4. SENSOR MAINTENANCE

For correct sensor maintenance:

1. Unscrew to remove the protective shield from the probe body and set aside.
2. Use the calibration beaker for cleaning
3. Use [HI76984942](#) probe maintenance kit. See section 16. ACCESSORIES for details.

Note: *If the sensors are removed from the probe body, the body of the sensors must be dried prior to installation to prevent water from entering the sockets.*

General Maintenance

- Inspect all sensor connectors for corrosion and replace sensors if necessary.
 - Inspect sensor o-ring for nicks or other damage and replace the o-ring if necessary.
-  Use only the supplied grease as some lubricants can cause the o-ring to expand.
- After prolonged storage or cleaning, calibration of the sensors is required.
 - After use rinse the probe with tap water and dry it. The pH electrode bulb and DO sensor must be kept moist.
 - Check GLP data under “Status” to ensure the sensor is still functioning properly.

pH and pH/ORP Sensor

- Remove the sensor protective shield.
- If the bulb and/or junction are dry, soak the electrode in [HI70300](#) Storage solution for at least 30 minutes.
- To ensure a quick response time, the glass bulb and the junction should be kept moist and not allowed to dry. Store the sensor with a few drops of [HI70300](#) Storage solution or pH 4.01 buffer in the protective cap. Tap water may also be used for a very short period (few days).

 Never use distilled or deionized water to store pH sensors.

- Inspect the sensor for scratches or cracks. If any are present, replace the sensor.
- Rinse the sensor in flowing water then clean by soaking it for 1 minute in [HI70670](#) Cleaning solution for mineral deposits or [HI70671](#) Cleaning & disinfection solution for algae, fungi and bacteria. After cleaning, soak the sensor in [HI70300](#) Storage solution for 30 minutes before calibrating.

DO Sensor

Cleaning the Smart Cap:

- Use a mild detergent and a soft-bristled toothbrush (not the brush in the maintenance kit) to clean.
- Rinse with water after cleaning and dry with a laboratory tissue.
- Hydrate in purified water before use.

Smart Caps require replacement on a yearly basis.

Note: *The first time a new DO Smart Cap is installed on a sensor and the sensor is installed in a probe and powered, the Cap start date will be registered in the Probe Status screen. After one year, a pop-up message will signal expiration.*

EC Sensor

After every series of measurements, rinse the probe with tap water.

If a more thorough cleaning is required:

- Clean the sensor with brush found in the maintenance kit to loosen any debris.
- Use a mild detergent to remove oily coatings.
- Ensure that the two cylindrical holes in the sensor are free of foreign material.
- Flush with purified water after cleaning.

6. GENERAL OPERATIONS

6.1. BATTERY CAPACITY & REPLACEMENT

HI98494 is equipped with a primary, internal Li-ion battery and supplied with 4 Alkaline, 1.5 V AA batteries. When the primary, rechargeable battery is completely discharged (0%), the meter will switch to the backup, Alkaline batteries.

The battery level indicators on the LCD indicate the battery life. If the battery capacity is less than 10% both indicators are displayed blinking. The primary battery should be recharged and the alkaline ones replaced.

The instrument is equipped with the BEPS (Battery Error Prevention System) feature, which automatically turns the instrument off when primary and Alkaline batteries reach 0%.

To replace the Alkaline batteries:

1. Turn off the instrument.
2. Remove the four screws on the back of the instrument to open the battery compartment.
3. Remove the old batteries.
4. Insert four new 1.5V AA batteries in the battery compartment while paying attention to the correct polarity. Do not mix old and new Alkaline batteries.
5. Close the battery compartment using the four screws.

Note: If the battery capacity is less than 25%, the backlight is no longer available.

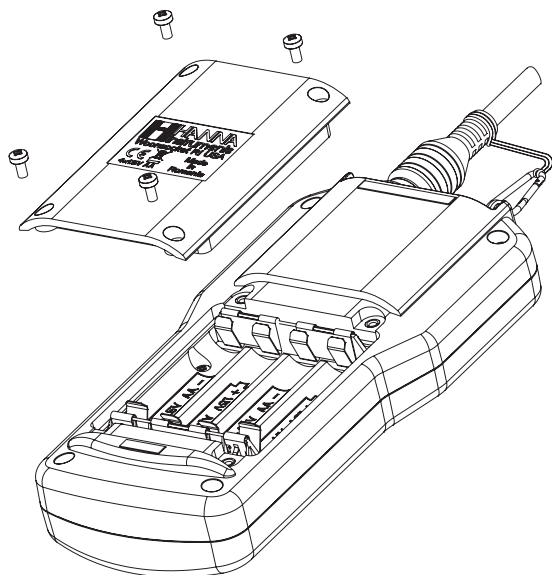

Battery Life

The battery life is dependent on the backlight usage, logging interval, and sensor configuration. The backlight will consume the most power.

Backlight	Logging Interval	Sensor Configuration	Battery Life
Off	1 second	pH / ORP, DO, EC	200 hours
Off	4 minutes	pH / ORP, DO, EC	260 hours
On	4 minutes	pH / ORP, DO, EC	50 minutes
Off	10 minutes	pH / ORP, DO, EC	270 hours
On	10 minutes	pH / ORP, DO, EC	50 minutes

6.2. CONNECTING THE PROBE

The multiparameter probe is connected to the meter through a waterproof Quick DIN connector, making attaching and removing the probe an easy process. When connected, the probe is automatically detected.

- With the meter off, connect the probe to the DIN connector on the top of the meter.
- Align the pins and key then push the plug into the socket.

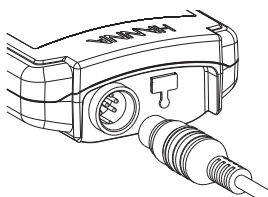

Note: If a DO cap is expired, a pop-up message will occur at probe connection or when meter starts with a connected probe. Pressing continue button disables it temporarily or until the next connection.

6.3. TURNING THE METER ON

After connecting the sensors to the probe and connecting the probe to the meter, turn the meter on by pressing the On / Off key.

At start-up the display will show the Hanna Instruments logo, meter name and firmware version.



After the initialization has been completed, if the probe is connected, the meter displays the Probe Status or the Tutorial Mode message.

The probe status screen identifies the probe and attached sensors. See section 6.4. TUTORIAL for information on the Tutorial mode.

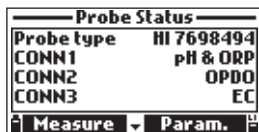

Press **Measure** to view the measurement screen.

Press **Param.** to open the Parameters menu. This screen can also be accessed from the main menu.

Press the down arrow key to view additional information about the probe.

6.4. TUTORIAL

If the tutorial is enabled, after the initialization has been completed, the Tutorial screen is displayed.

Press **ESC** to view the Probe Status screen and skip the tutorial.

Press **Next** to start the tutorial. The following tutorials are available: Sensor Preparation, Sensor Maintenance, and Sensor Installation.



Press **Select** to view the selected tutorial.

6.5. BASIC OPERATIONS

The main operating modes are setup, measurement and logging.

The instrument can be configured to display measurement data for all enabled parameters (up to 12).

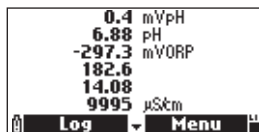
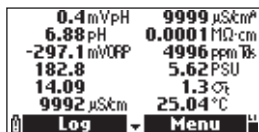

Press the arrow keys to scroll between measured data in all available parameters.

The display has a feature that automatically sizes the digits to fit the screen. With one measurement the digits will be largest.

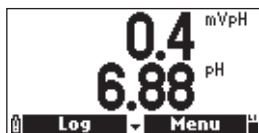
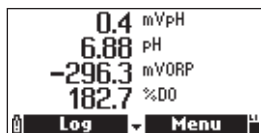

Press the keys on the alphanumeric keypad (1 - 7) to select number of parameters displayed at one time.

Note: pressing 7 will display up to 12 parameters simultaneously.

Press **Measure** for **Log** and **Menu** functional keys to be displayed.
 Press **Log** to view the Log menu. User can log a single sample or start an interval log.
 See section 13. LOGGING for detailed description.
 Press **Menu** to select the measurement parameters (see section 7. PARAMETER SETUP).
 To calibrate the sensors, see section 8. CALIBRATION.
 To change system settings, see section 9. SYSTEM SETUP.
 To enable or disable Bluetooth and view the meter and probe status, see section 11. STATUS.

6.6. HELP

To view the context sensitive help, press the **HELP** key. Use the arrow keys to scroll through the text.
 To return to the previous screen, press the **HELP** or **ESC** key.

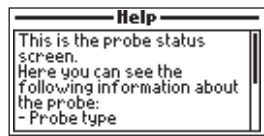

6.7. FUNCTIONAL DIAGRAM OF THE INSTRUMENT

Menu and **Log** functional keys help user navigate through all measurement operations. The following diagrams present an overview of possible functions.

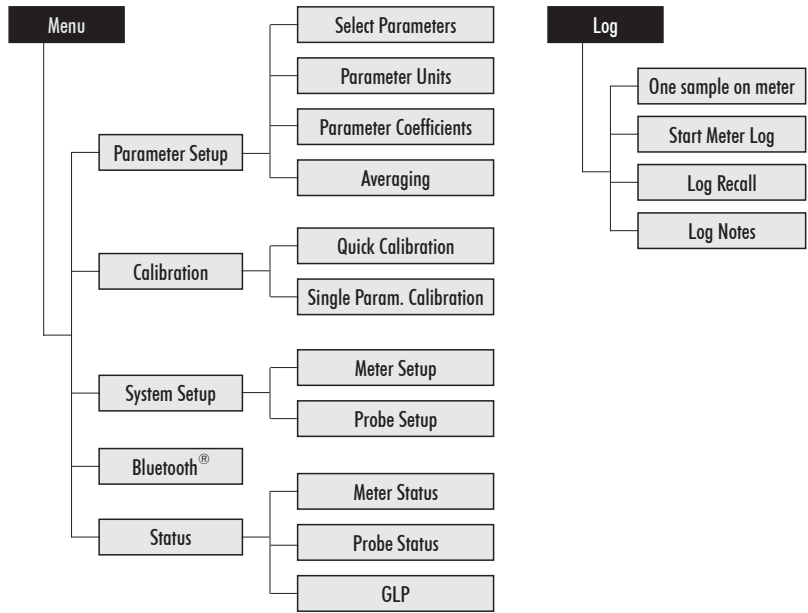

7. PARAMETER SETUP

From the measurement screen press **Menu**. Use the arrow keys to highlight “Parameter Setup” and press **Select**. Use the arrow keys to highlight the desired option and press **Select**.

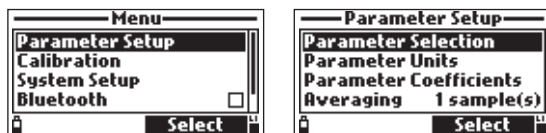

Note: Logged data saved on the meter will be changed to selected parameter units or coefficients.

7.1. PARAMETER SELECTION

Use the arrow keys to scroll through the list of available parameters.

Press the corresponding functional key to enable or disable the highlighted parameters (or Enable / Disable all option). A checked box indicates that the parameter is enabled.



Note: When the password protection is enabled, authentication will be required before any parameter modification.

7.2. PARAMETER UNITS

When selected parameters have a single measurement unit, the Parameter Units screen will not be displayed. If a parameter has been disabled the units will not be displayed.

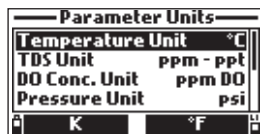

Temperature Unit

Option: °C, °F, K

Press the functional key to select the desired temperature unit.



TDS Unit

Option: ppm - ppt or mg/L - g/L

Press the functional key to select the desired TDS unit.

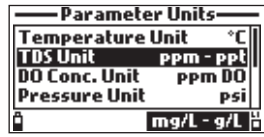

DO Concentration Unit

Option: ppm or mg/L

DO concentration is calculated using % saturation, pressure and temperature.

Press the functional key to select the desired DO concentration unit.



Pressure Unit

Option: psi, mmHg, inHg, mbar, atm, kPa

Press **Modify** and use the arrow keys to select the desired pressure unit.

Press **Select** to confirm or the **ESC** key to return to the previous screen.

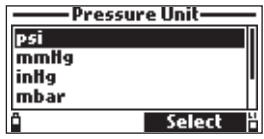
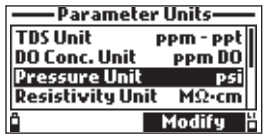

Resistivity Unit

Option: Ω-cm, kΩ-cm, MΩ-cm

Resistivity is calculated from the conductivity measurement.

Press the functional key to select the desired resistivity unit.



Seawater Sigma (σ) Unit

Option: σ_T , σ_0 , σ_{15}

Seawater sigma is calculated from the conductivity measurement and depends on water pressure, temperature, and salinity.

Press the functional key to select the desired reference temperature (current temperature, 0 °C or 15 °C).

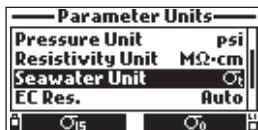

EC Resolution

Option: Auto, Auto mS/cm, 1 μ S/cm, 0.001 mS/cm, 0.01 mS/cm, 0.1 mS/cm, 1 mS/cm

Press **Modify** and use the arrow keys to select the desired EC resolution.

Press **Select** to confirm or the **ESC** key to return to the previous screen.

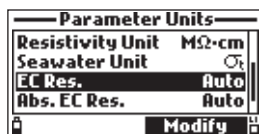

Auto: The meter automatically chooses the range (μ S/cm or mS/cm) to optimize the measurement.

Auto mS/cm: The meter automatically chooses the resolution to optimize the measurement, readings will be in mS/cm only.

Specified numeric resolution: The meter will not autorange, the measurement will be displayed with the selected resolution only.

Absolute EC Resolution

Option: Auto, Auto mS/cm, 1 μ S/cm, 0.001 mS/cm, 0.01 mS/cm, 0.1 mS/cm, 1 mS/cm

Press **Modify** and use the arrow keys to select the desired absolute EC resolution.

Press **Select** to confirm or the **ESC** key to return to the previous screen.



- Auto: The meter automatically chooses the range ($\mu\text{S}/\text{cm}$ or mS/cm) to optimize the measurement.
- Auto mS/cm : The meter automatically chooses the resolution to optimize the measurement, readings will be in mS/cm only.
- Specified numeric resolution: The meter will not autorange, the measurement will be displayed with the selected resolution only.

Note: A small letter "A" added to the $\mu\text{S}/\text{cm}$ or mS/cm unit refers to an absolute conductivity value.

TDS Resolution

Option: Auto, Auto ppt, 1 ppm, 0.001 ppt, 0.01 ppt, 0.1 ppt, 1 ppt

Press **Modify** and use the arrow keys to select the desired TDS resolution.
 Press **Select** to confirm or the **ESC** key to return to the previous screen.

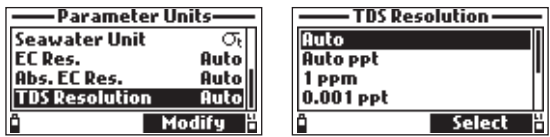

- Auto: The meter automatically chooses the range (ppm or ppt) to optimize the measurement.
- Auto ppt: The meter automatically chooses the resolution to optimize the measurement, readings will be in ppt only.
- Specified numeric resolution: The meter will not autorange, the measurement will be displayed with the selected resolution only.

7.3. PARAMETER COEFFICIENTS

EC Reference Temperature

Option: 20 °C or 25 °C

This value is used for temperature compensated conductivity. All EC measurements will be referenced to the conductivity of a sample at this temperature.

Press the functional key to select the desired EC reference temperature.

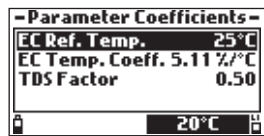

EC Temperature Coefficient (Beta, β)

Option: 0.00 to 6.00 %/°C

β is a function of the solution being measured. For freshwater samples β is approximately 1.90 %/°C. If the actual temperature coefficient of the sample is known, press **Modify** to enter the value.

Press **Accept** to confirm the value or the ESC key to return to the previous screen.

-Parameter Coefficients-	
EC Ref. Temp.	25°C
EC Temp. Coeff.	5.11 %/°C
TDS Factor	0.50
Modify	

EC Temp. Coeff.	
5.11	
0.00...6.00 %/°C	
←	Accept

TDS Factor

Option: 0.00 to 1.00

TDS is a calculated value based on the conductivity of the solution ($TDS = \text{factor} \times EC_{25}$). A typical TDS factor for strong ionic solutions is 0.50, while for weak ionic solutions is 0.70 (e.g fertilizers).

Press **Modify** to enter the value.

Press **Accept** to confirm the value or the ESC key to return to the previous screen.

-Parameter Coefficients-	
EC Ref. Temp.	25°C
EC Temp. Coeff.	5.11 %/°C
TDS Factor	0.50
Modify	

TDS Factor	
0.50	
0.00...1.00	
←	Accept

7.4. AVERAGING

Option: 1 to 20 samples

Averaging is a software filter to minimize sensor noise and provide more stable readings. It is particularly useful to get a representative reading of the “average” value from flowing water. Averaging will affect all measurements. If a fast response is needed, this value should be kept low.

Press **Modify** to select the number of samples to average.

Press **Accept** to confirm the value or the ESC key to return to the previous screen.

Parameter Setup	
Select Parameters	
Parameter Units	
Parameter Coefficients	
Averaging	1 sample(s)
Modify	

Averaging	
01	
01...20 sample(s)	
←	Accept

Note: When logging the first sample using averaging, it will be delayed by a few seconds.

8. CALIBRATION

In the measurement screen press **Menu**. Use the arrow keys to highlight “Calibration” and press **Select**. Use the arrow keys to highlight the desired option and press **Select**.



All calibration data is stored in the non volatile probe memory, allowing probes to be connected to different meters without recalibration.

There are two types of calibrations available.

Quick calibration: Is a single point pH, conductivity and / or dissolved oxygen calibration.

Single parameter calibration: Allows each parameter (pH, ORP, dissolved oxygen, conductivity, temperature, pressure) to be calibrated individually.

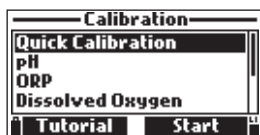

Notes: The password will be required if password protection is enabled.

Calibration Guidelines

- Set up a routine service schedule where measurement integrity is validated.
- Do not handle the sensing surfaces of the sensors.
- Avoid rough handling and abrasive environments that can scratch the reactive surfaces of the sensors.
- Avoid long-term exposure of sensors to bright sunlight. If possible, calibrate in a shaded area.
- Discard standards after use. Do not return the used standards to the bottles of “fresh” solution.
- For measurements across a temperature gradient (when water temperature is drastically different from the standards), allow the sensors to reach thermal equilibrium before conducting calibrations or making measurements. The heat capacity of the probe is much greater than the air and the small beakers of calibration standards.
- During calibration the temperature probe should also be in the calibration solution.

8.1. QUICK CALIBRATION

The quick calibration provides a single point calibration for pH, conductivity and / or dissolved oxygen sensors. Users can select to calibrate all sensors or any sensor combination.

If a sensor is not calibrated or to skip a calibration, press **Skip**.

Note: If the tutorial mode is enabled, press Tutorial and follow the messages on the screen.

1. Remove the shield from the probe and rinse the probe with purified water.
2. Fill the calibration beaker 2/3 full with **HI9828-0** calibration solution.
3. Immerse the sensors in the calibration solution. Raise and lower the probe several times. Discard the solution.
4. Fill the calibration beaker 2/3 full with **HI9828-0** calibration solution.
5. Slowly place the sensors in the solution and dislodge bubbles that may adhere to the sensors. Screw the calibration beaker completely onto the probe body. Some solution may overflow.
6. Wait a few minutes for the measurement to stabilize. From the "Calibration" menu select "Quick Calibration" and press **Start**. A three item calibration menu will appear. "pH" will start to blink along with the "Not ready" message.
7. The "Ready" message will appear when the pH reading has stabilized. Press **Confirm** to store the calibration point. The "Storing" message and a checkmark will appear in the box next to "pH" to indicate a successful calibration.

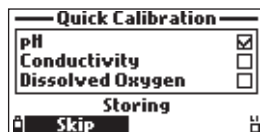
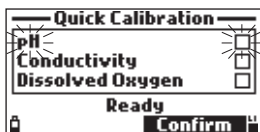
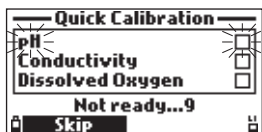

8. "Conductivity" will start to blink along with the "Not ready" message.
9. The "Ready" message will appear when the EC reading has stabilized. Press **Confirm** to store the calibration point. The "Storing" message and a checkmark will appear in the box next to "Conductivity" to indicate a successful calibration.

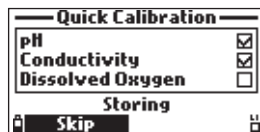
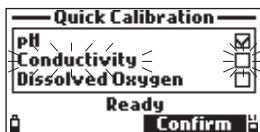
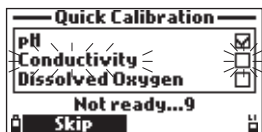

10. The message "Empty the beaker." will appear. Unscrew the calibration beaker and discard the solution.

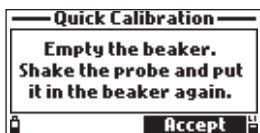

11. Shake any remaining solution off the probe. No droplets should remain on the DO sensor cap sensing surface.

Note: Do not wipe the sensing surface as damage may occur.

12. Shake any remaining solution out of the beaker. The calibration beaker should not be dry.
13. Screw the empty calibration beaker onto the probe body. Do not tighten the calibration beaker on the probe threads.
14. Wait at least 15 minutes for the air to become saturated with water vapor. Press **Accept**. "Dissolved Oxygen" will start to blink along with the "Not ready" message.
15. The "Ready" message will appear when the DO reading has stabilized. Press **Confirm** to store the calibration point. The "Calibration complete" message and a checkmark will appear in the box next to "Dissolved Oxygen" to indicate a successful calibration.

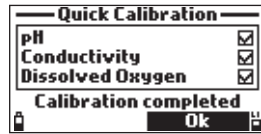
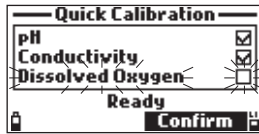
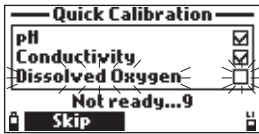

16. Press **OK** to return to the calibration menu.

Note: To quit the quick calibration procedure, press ESC key at any time.

Error Message

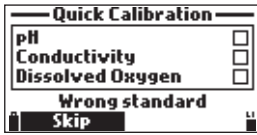

"Wrong standard" is displayed when the input is not within the acceptable range.

8.2. pH CALIBRATION

There are two options available:

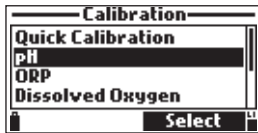

Calibrate pH: The user can perform a new calibration using up to 3 buffers (pH 4.01, 6.86, 7.01, 9.18, 10.01 or one custom buffer). When a three-point calibration is performed, new data overwrites the old one. With a single or two-point calibration the meter will also use information from the previous calibration, if available.

Restore Factory Calib.: The user can restore the factory calibration if a new pH sensor has been installed. Some messages displayed during calibration are based on previous calibration data. A user calibration should follow immediately.

Procedure

Note: If the tutorial mode is enabled, press **Tutorial** and follow the messages on the screen.

1. Remove the shield from the probe and rinse the probe with purified water.
2. Fill the calibration beaker 2/3 full with the first buffer solution.
3. Immerse the sensors in the buffer solution. Raise and lower the probe several times. Discard the solution.
4. Fill the calibration beaker 2/3 full with the first buffer solution.
5. Slowly place the sensors in the selected buffer. Dislodge bubbles that may adhere to the sensors.
6. Screw the calibration beaker completely onto the probe body. Some solution may overflow.
7. Wait a few minutes for the measurement to stabilize.
8. Use the arrow keys to select "Calibrate pH" and press **Start** to start the calibration. The temperature, pH buffer value and the "Not ready" message are displayed.
9. If necessary, press **Cal. point** to select the correct buffer. To use a custom buffer, press **Custom**. A text box window will appear. Use the keypad to enter the value of the buffer (0.00 to 14.00 pH) at the current temperature. Press **Accept** to confirm the buffer value.

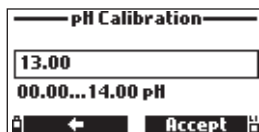
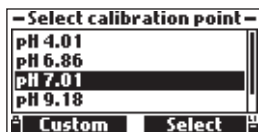

10. Once the reading has stabilized the countdown timer will count down until the display shows the "Ready" message.
11. Press **Confirm** to accept the calibration point.



12. After the calibration point is confirmed, to avoid cross-contamination, immerse the sensors in the next calibration buffer rinse solution and stir gently.
13. Repeat the calibration procedure outlined above with the second and third buffers.

Note: To save a one or two-point calibration press the **ESC** key after the buffer is confirmed. The message "Storing" followed by "Calibration completed" will be displayed.

14. After the third buffer has been confirmed, the message “Storing” followed by “Calibration completed” will be displayed. Press **OK** to return to the calibration menu or **Measure** to return to the measurement screen.



Error Messages

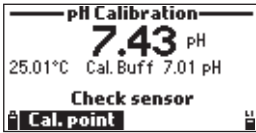

“Check sensor” is displayed when the electrode is broken, very dirty or the user has attempted to calibrate the same buffer value twice.



“Wrong buffer” is displayed when the pH reading is too far from the selected buffer value. This is often seen immediately after a buffer calibration has been completed but before the pH sensor has been moved to the next buffer. Check if the correct calibration buffer has been selected.

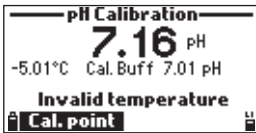

“Invalid temperature” is displayed when the buffer temperature is outside the acceptable range.



“Contaminated buffer” is displayed when the buffer is contaminated or the sensor is broken or very dirty.

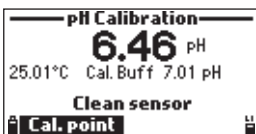

“Clean sensor” is displayed when the electrode is broken or very dirty.



“Wrong” is displayed when erroneous slope condition. The slope difference between the current and previous calibration exceeds the slope window (80% to 110%). Press **Clear** to cancel the old data and continue the calibration procedure, or press **ESC** key to quit the pH calibration mode.

8.3. ORP CALIBRATION

There are two options available:



Custom ORP: The user can perform a single point calibration using a custom point.

Restore Factory Calib.: The user can restore the factory calibration if a new sensor has been installed.

Calibration is used to compensate for changes in the potential due to contamination of the sensing surface and drift in the reference electrode.

Calibration is not typically required but it does establish a baseline that can be used for future validations.

Note: ORP values are not temperature compensated and can change with temperature. ORP values should be reported with the reference electrode used and the temperature. The [HI7698194-1](#) reference is a Ag/AgCl reference with Cl⁻ activity equivalent to 3.5M KCl.

Procedure

Note: If the tutorial mode is enabled, press **Tutorial** and follow the messages on the screen.

1. Remove the shield from the probe. Rinse the probe with purified water.
2. Fill the calibration beaker 2/3 full with the ORP test solution with a known concentration.
3. Immerse the sensors in the solution. Raise and lower the probe several times then discard this solution.
4. Fill the calibration beaker 2/3 full with the ORP test solution with a known concentration.
5. Slowly place the sensors in the solution. Dislodge bubbles that may adhere to the sensors.
6. Screw the calibration beaker completely onto the probe body. Some solution may overflow.
7. Wait a few minutes for the measurement to stabilize. Use the arrow keys to select "Custom ORP" and press **Start** to start the calibration. A text box window will appear. Use the keypad to enter the value of the solution at the current temperature. Press **Accept** to confirm the calibration point.

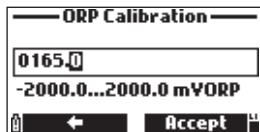

8. The stability counter will count down until the display shows the "Ready" message.

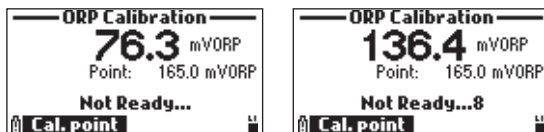

- Press **Confirm** to accept the calibration point. The message “Storing” followed by “Calibration completed” will be displayed.



- Press **OK** to return to the calibration menu or **Measure** to return to the measurement screen.

Error Message



“Wrong standard” is displayed when the ORP input is not within the acceptable range.

8.4. DISSOLVED OXYGEN CALIBRATION

There are three options available:

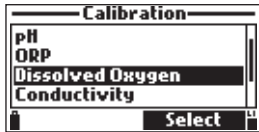

% DO Saturation: The user can perform a one or two-point calibration using 100 % and 0 % saturation or a one-point calibration using a custom solution (50 to 500 % saturation).

DO Concentration: The user can perform a single point calibration using a custom point.

Restore Factory Calib.: The user can restore the factory calibration if a new sensor has been installed.

Note: When the % DO range is calibrated, the DO concentration range is also calibrated, and vice versa.

The accuracy of dissolved oxygen measurement is directly related to the sensing surface cleanliness and calibration technique. Oily coatings and biological contaminations are the primary cause of calibration drift.

A standard solution or a reference DO meter may be used to compare readings during calibration.

Note: If the tutorial mode is enabled, press **Tutorial** and follow the messages on the screen.

% DO Saturation Calibration

Remove the shield from the probe and rinse the probe with purified water.

Shake any remaining solution off the probe. No droplets should remain on the DO sensor sensing surface.

Calibration at 100 % and 0 % Saturation

1. To calibrate at 100 % saturation, place a moistened sponge in the bottom of the calibration beaker.
2. Place the calibration beaker on the probe body. Do not tighten the calibration beaker on the probe threads.
3. Wait at least 15 minutes for the air to become saturated with water vapor. This condition corresponds to 100 % air saturated water at the temperature of measurement.
4. Press **Start** to start the calibration.
5. The reading, temperature, calibration point and the “Not ready” message are displayed.
6. Once the reading has stabilized the countdown timer will count down until the display shows the “Ready” message.
7. Press **Confirm** to accept the calibration point.



8. To calibrate at 0 %, fill the calibration beaker 2/3 full with **HI7040** zero oxygen solution.
9. Slowly place the sensors in the solution. Dislodge bubbles that may adhere to the sensors.
10. Screw the calibration beaker completely onto the probe body. Some solution may overflow.
11. The stability timer will count down until the display shows the “Ready”.
12. Press **Confirm** to accept the calibration point. The message “Storing” followed by “Calibration completed” will be displayed.
13. Press **OK** to return to the calibration menu or **Measure** to return to the measurement screen.



Notes: To save a one calibration press the ESC key after the standard is confirmed.

Single point Calibration at 100 %, 0 %, or Custom value

1. For 100.0%:
 Select Cal.point and select 100.0%. Follow steps 1-7 from previous section.
 Press **Confirm** when “Ready” message appears.



2. For 0.0%:
 Select Cal.point and select 0.0%. Follow steps 8-13 from previous section.
 Press **Confirm** when “Ready” message appears.
3. For a Custom value:
 Place probe in water sample you wish to calibrate. Determine the value of the water sample independently. Select Cal.point and select Custom. A text box will appear. Insert the % Saturated value using the keypad then press **Accept**.

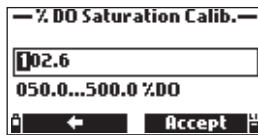

4. The following messages will appear: “Storing” and “Calibration completed”.
5. Press **OK** to return to the “Calibration” menu.
6. Press **ESC** twice to return to the main menu.
7. Press **Measure** to return to the measurement screen.

DO Concentration Calibration

1. Remove the shield from the probe. Rinse the probe with purified water.
2. Fill the calibration beaker 2/3 full with the test solution.
Note: The concentration of the solution should be determined independently.
3. Immerse the sensors in the solution. Raise and lower the probe several times then discard this solution. Alternately, place probe directly in the water sample needed to calibrate in.
4. Fill the calibration beaker 2/3 full with the test solution.
5. Slowly place the sensors in the solution. Dislodge bubbles that may adhere to the sensors.
6. Screw the calibration beaker completely onto the probe body. Some solution may overflow.
7. Wait a few minutes for the measurement to stabilize.
8. Use the arrow keys to select “DO Concentration” and press **Start** to start the calibration.

9. A text box window will appear. Use the keypad to enter the value of the standard. Press **Accept** to confirm.

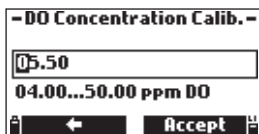

10. The stability timer will count down until the display shows the "Ready" message.

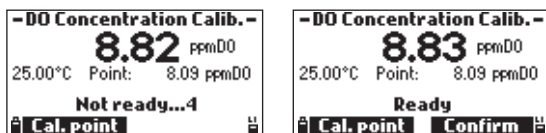

11. Press **Confirm** to accept the value. The message "Storing" followed by "Calibration completed" will be displayed.

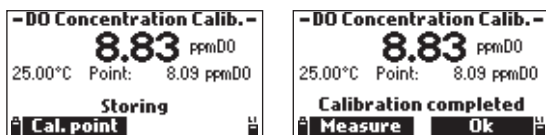

12. Press **OK** to return to the calibration menu or **Measure** to return to the measurement screen.

Error Messages

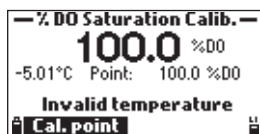

"Invalid temperature" is displayed when the temperature input is not within the acceptable range (0 to 50 °C).



"Wrong standard" is displayed when the DO input is not within the acceptable range.

8.5. CONDUCTIVITY CALIBRATION

There are four options available:

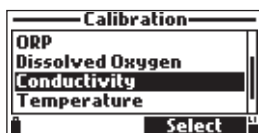

- Conductivity: The user can perform a one-point calibration using a standard solution. The calibration is temperature compensated.
- Absolute Conductivity: The user can perform a one-point calibration with a known conductivity solution that is not temperature compensated.
- Salinity: The user can perform a one-point calibration with a known salinity solution (PSU).
- Restore Factory Calib.: The user can restore the factory calibration if a new sensor has been installed.

Notes: *The probe shield or calibration beaker must be used during calibration.*

When the Conductivity is calibrated, also the Absolute Conductivity and Salinity is calibrated, and vice versa. A Conductivity calibration is recommended.

Conductivity calibrations are used to correct for variations in cell factors. Oily coatings and biological contaminations can cause changes in the cell geometry. The EC electrodes are located inside two small channels on the bottom of the sensor. They can be cleaned with the small brush from the maintenance kit. A mild detergent can be used to remove oily coatings. Flush the electrodes with water thoroughly after cleaning.

Note: *If the tutorial mode is enabled, press Tutorial and follow the messages on the screen.*

Conductivity Calibration

1. Remove the shield from the probe. Rinse the probe with purified water.
2. Fill the calibration beaker 2/3 full with the conductivity standard solution.
3. Immerse the sensors in the solution. Raise and lower the probe several times then discard this solution.
4. Fill the calibration beaker 2/3 full with the conductivity standard solution.
5. Slowly place the sensors in the solution. Dislodge bubbles that may adhere to the sensors.
6. Screw the calibration beaker completely onto the probe body. Some solution may overflow.
7. Use the arrow keys to select “Conductivity” and press **Start** to start the calibration.
8. If necessary, press **Cal. point** to select the correct standard. To use a custom standard, press **Custom**. A text box window will appear. Use the keypad to enter the value of the standard (100 to 200000 $\mu\text{S}/\text{cm}$) at the current temperature. Press **Accept** to confirm the standard value.

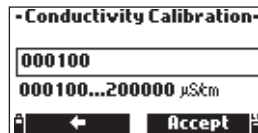
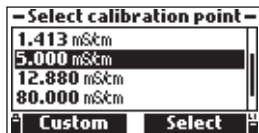

9. Once the reading has stabilized, the stability timer will count down until the display shows the “Ready” message.



10. Press **Confirm** to save the calibration. The message “Storing” followed by “Calibration completed” will be displayed.
11. Press **OK** to return to the calibration menu or **Measure** to return to the measurement screen.

To Calibrate Offset

1. Remove the shield from the probe. Rinse the probe with purified water.
2. Shake all water from the probe.
3. Use a tissue to dry off the EC sensor. There should be no moisture in or on the sensor.
4. Suspend the probe in the air (infinite resistance).
5. Press Start to initiate the calibration.
6. Press Cal point and Use the arrow keys to choose 0uS/cm. Press Select.
7. Once the reading has stabilized, the stability timer will count down until the display shows the “Ready” message.
8. Press Confirm. Calibration Complete will be displayed.
9. Press OK to return to the calibration menu

Absolute Conductivity (EC) Calibration

1. Remove the shield from the probe. Rinse the probe with purified water.
2. Fill the calibration beaker 2/3 full with the test solution with known concentration.
3. Immerse the sensors in the solution. Raise and lower the probe several times then discard this solution.
4. Fill the calibration beaker 2/3 full with the test solution with known concentration.
5. Slowly place the sensors in the solution. Dislodge bubbles that may adhere to the sensors.
6. Screw the calibration beaker completely onto the probe body. Some solution may overflow.
7. Wait a few minutes for the measurement to stabilize. Use the arrow keys to select “Absolute Conductivity” and press **Start** to start the calibration. A text box window will appear. Use the keypad to enter the value of the standard (100 to 200000 µS/cm) at the current temperature. Press **Accept** to confirm the standard value.

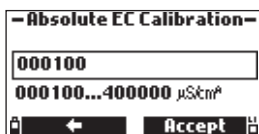

- The stability counter will count down until the display shows the “Ready” message.

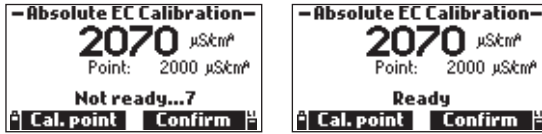

- Press **Confirm** to save the calibration. The message “Storing” followed by “Calibration completed” messages will be displayed.
- Press **OK** to return to the calibration menu or **Measure** to return to the measurement screen.

Salinity Calibration

The measurement of salinity is based on the Practical Salinity Scale which uses the EC measurement. If the user has a standard with known PSU value, it may be used to calibrate the conductivity sensor.

- Remove the shield from the probe. Rinse the probe with purified water.
- Fill the calibration beaker 2/3 full with salinity standard of a known value.
- Immerse the sensors in the solution. Raise and lower the probe several times then discard this solution.
- Fill the calibration beaker 2/3 full with the salinity standard.
- Slowly place the sensors in the solution. Dislodge bubbles that may adhere to the sensors.
- Screw the calibration beaker completely onto the probe body. Some solution may overflow.
- Wait a few minutes for the measurement to stabilize. Use the arrow keys to select “Salinity” from the Conductivity Calibration list and press **Start** to start the calibration. A text box window will appear. Use the keypad to enter the value of the standard (5.00 to 70.00 PSU) at the current temperature. Press **Accept** to confirm the standard value.

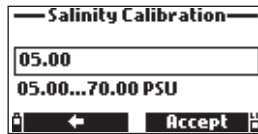

- The stability counter will count down until the display shows the “Ready” message.

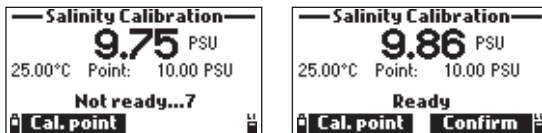

- Press **Confirm** to save the calibration. The message “Storing” followed by “Calibration completed” will be displayed.
- Press **OK** to return to the calibration menu or **Measure** to return to the measurement screen.

Error Messages



“Invalid temperature” is displayed when the temperature input is not within the acceptable range (0 to 50 °C).



“Wrong standard” is displayed when the conductivity input is not within the acceptable range.

8.6. TEMPERATURE CALIBRATION

There are two options available:

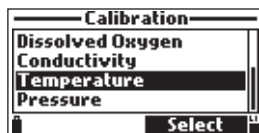

Calibrate Temperature: The user can perform a one-point calibration.

Restore Factory Calib.: Clears previous user calibration.

Procedure

Note: If the tutorial mode is enabled, press **Tutorial** and follow the messages on the screen.

1. Remove the shield from the probe. Rinse the probe with purified water.
2. Place the probe in an isothermal bath with a reference instrument.
3. Allow the probe to come to thermal equilibrium.
4. Use the arrow keys to select “Calibrate Temperature” and press **Start** to start the calibration.
5. A text box window will appear. Use the keypad to enter the calibration temperature (-5 to 50 °C). Press **Accept** to confirm the value.

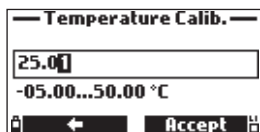

6. The stability timer will count down until the display shows the “Ready” message.



- Press **Confirm** to store the calibration point. The message “Storing” followed by “Calibration completed” is displayed.

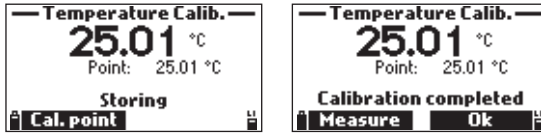

- Press **OK** to return to the calibration menu or **Measure** to return to the measurement screen.

Error Message



“Wrong standard” is displayed when the temperature input is not within the acceptable range.

8.7. PRESSURE CALIBRATION

There are two options available:

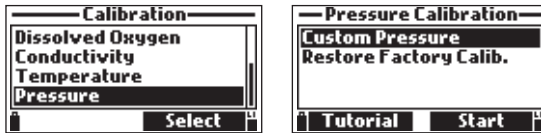

- Custom Pressure: The user can perform a one-point calibration.
- Restore Factory Calib.: Clears previous user calibration.

Procedure

Note: If the tutorial mode is enabled, press **Tutorial** and follow the messages on the screen.

- Use a reference barometer to obtain the true local barometric pressure reading.
- Use the arrow keys to select “Custom Pressure” and press **Start** to start the calibration.
- A text box window will appear. Use the keypad to enter the calibration pressure in units of psi (8.702 to 16.436 psi). Press **Accept** to confirm the standard value.

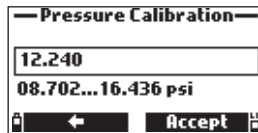

- The stability counter will count down until the display shows the “Ready” message. Press **Confirm** to store the calibration point.



- After confirmation, the message “Storing” followed by “Calibration completed” will be displayed.



- Press **OK** to return to the calibration menu or **Measure** to return to the measurement screen.

Error Message



“Wrong standard” is displayed when the atmospheric pressure input is not within the acceptable range.

9. SYSTEM SETUP

In the measurement screen press **Menu**. Use the arrow keys to highlight “System Setup” and press **Select**. Use the arrow keys to highlight the desired option and press **Select**.

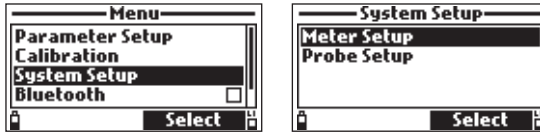

Note: When the password protection is enabled, authentication will be required before any modification.

9.1. METER SETUP

There are 14 items in the Meter Setup menu.

Pressing the corresponding numerical value will bring you directly to that position in the list.

- | | | |
|-----------------|---------------------|-----------------------------|
| 1 Menu | 6 Error Beep | 11 Meter ID |
| 2 Date | 7 Decimal Separator | 12 Language |
| 3 Auto Poweroff | 8 LCD Contrast | 13 Delete Paired Devices |
| 4 Tutorial | 9 LCD Backlight | 14 Restore Factory Settings |
| 5 Key Beep | 10 Meter Password | |

Time

Option: 12 or 24 hours

Press **Modify** and set the time using the keypad.

Press **Format** to change between 12 and 24 hours.

When the 12 hour format is used. Use the down arrow to get to the ante or post meridian abbreviation.

The first letter can be changed by pressing any key.

Press **Accept** to save the option or press **ESC** key to return to the menu.

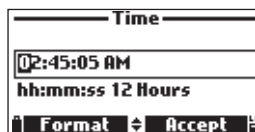
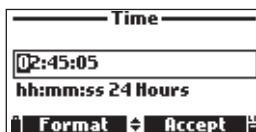
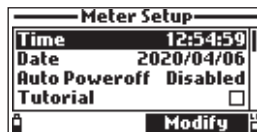

Date

Option: DD/MM/YYYY, MM/DD/YYYY, YYYY/MM/DD, YYYY-MM-DD, MM-DD-YYYY, DD-MM-YYYY

Press **Modify** and set the date using the keypad.

Press **Format** to change the date format.

Press **Accept** to save or press **ESC** key to return to the menu.

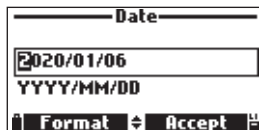
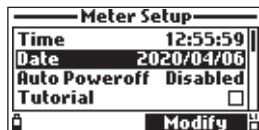

Auto Poweroff

Option: Disabled, 5, 10, 15, 20, 30, 60 minutes

The function is used to save battery life. After the set time has elapsed, the meter will:

1. Automatically switch off, if in normal measurement mode. Press **On/Off** key to switch on again.
2. Enter a sleeping mode, if the continuous logging mode is selected with a minimum logging interval of 30 seconds. The "Power save mode" message and the **Wake up** functional key will be displayed on the LCD when it goes into this mode. Logging is not stopped. Pressing **Wake up** will reactivate the display.

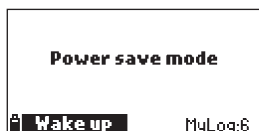
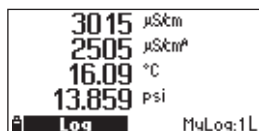
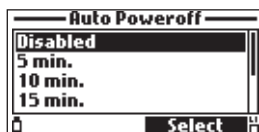
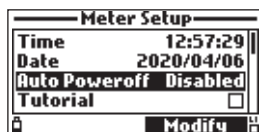

Tutorial

Option: Enabled or Disabled

When enabled, the user will be guided step-by-step through the sensor preparation, sensor maintenance, sensor installation and calibration procedures.



Key Beep

Option: Enabled or Disabled

When enabled, an acoustic signal is heard every time a key is pressed.
Press the functional key to select the desired option.

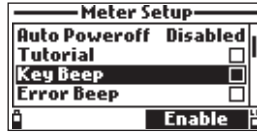

Error Beep

Option: Enabled or Disabled

When enabled, a short beep is heard every time an incorrect key is pressed. A long beep alert sounds when the pressed key is not active or an error is detected.
Press the functional key to select the desired option.

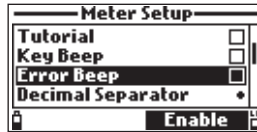

Decimal Separator

Option: Comma (,) or Period (.)

The user can select the type of decimal separator.
Press the functional key to select the desired option.

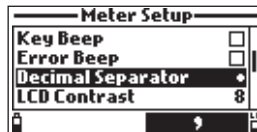

LCD Contrast

Option: 0 to 15

This function allows the adjustment of the LCD contrast.
Press **Modify** and use the arrow keys to increase or decrease the contrast.
Press **Accept** to save or press **ESC** key to return to the menu.

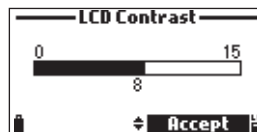
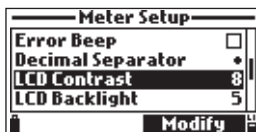

LCD Backlight

Option: 0 to 10

This function allows the adjustment of the LCD backlight intensity.

Press **Modify** and use the arrow keys to change the backlight intensity.

Press **Accept** to save or press **ESC** key return to the menu.



Meter Password

The meter password protects against unauthorized configuration changes and prevents log data from being deleted. When implemented, certain settings and functions require authentication before modifying or viewing. Once the password is entered, it will not be required until the meter is turned on again.

To enable the password, proceed as follows:

1. Select "Meter Password" and press **Modify**.
2. Enter a 6 digit password in the text box and press **Accept**.

Note: While typing, the characters are masked with a "*" (star) symbol.

3. Reenter the password. Press **Accept** to save or press **ESC** key to return to the menu.
4. The meter returns to the Meter Setup menu and the check mark indicates that the password protection has been enabled.

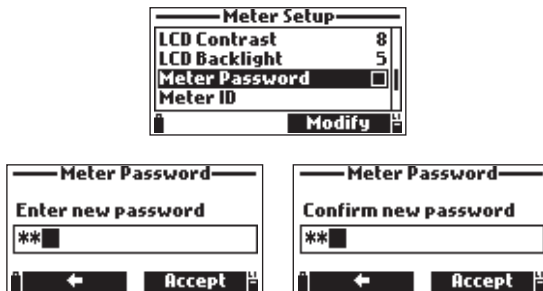

To disable the password protection:

1. Select "Meter Password" and press **Modify**.
2. Enter the password and then press **Disable**. "No password" appears in the text box.
3. Press **Accept** to save or press **ESC** key to return to the menu.

Meter ID

Option: Up to 14 characters

Press **Modify** to enter meter's ID setup screen.

Use the keypad to set or change the meter's ID. Press **Accept** to save or press **ESC** key to return to the menu.

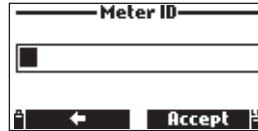
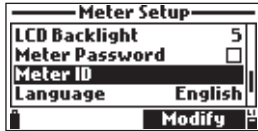

Language

Option: English, Deutsch, Español, Français, Magyar, Italiano, Leituviu, Nederlands, Polski, Portugues, Româna

The language used in the meter's user interface can be changed.

Press **Modify** and use the arrow keys to change the language.

Press **Select** to save or press **ESC** key return to the menu.

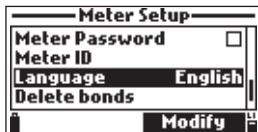

Delete Paired Devices

This function removes all previous Bluetooth® connections.

Press **Select** to delete all paired devices. The meter will ask for confirmation.

Press **Yes** to confirm or **No** to return to the menu. "Previous bonds removed" message will be displayed.

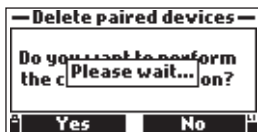

Restore Factory Settings

This function restores measurement settings to their original factory values. This includes measurement units, coefficients, other measurement configurations and all logged data. The calibration for the sensor is not affected.

Highlight “Restore factory settings” and press **Select**. Press **Yes** to confirm or press **No** to return to the menu.

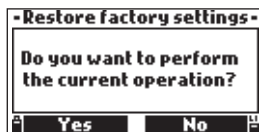

9.2. PROBE SETUP

Probe ID

Option: Up to 14 characters

Press **Modify** to enter probe ID setup screen. Use the keypad to set or change the probe ID. Press **Accept** to save or press **ESC** key return to the menu.

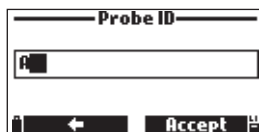
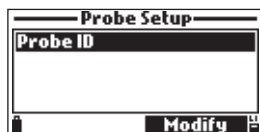

10. BLUETOOTH®

HI98494 can be connected to the Hanna Lab App (version 3.0 or higher) using Bluetooth. The Hanna Lab App is available on iOS and Android devices. Upgrade your device to the latest Firmware Version (minimum 3.0) that was developed to work with the HI98494. It can be used to view log recall, download logs and view the HI98494 information.

For additional information download the latest Hanna Lab App.

- Logs can be shared as a CSV or PDF file.
- GLP data can be viewed for all parameters when a log is downloaded to the iOS and Android device.
- Measurement units can be modified independently of the meter settings.
- Downloaded data is displayed in a table or a graph.

In the measurement screen press **Menu**. Use the arrow keys to highlight “Bluetooth” and press **Enable** or **Disable**.

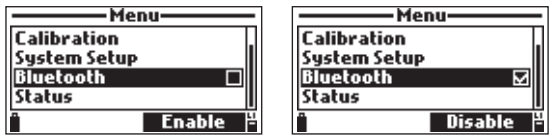

When a device is paired with the meter for the first time, the meter will generate a password.



Enter the password to allow the pairing. The password is saved for future connections or until paired devices are deleted (see section 9. SYSTEM SETUP).

Press the arrow key to return to the previous screen.

11. STATUS

In the measurement screen, press **Menu**. Use the arrow keys to highlight “Status” and press **Select**. Use the arrow keys to highlight the desired option and press **Select**.



11.1. METER STATUS

Meter Status displays information related to the batteries, charging status, logging, internal temperature, password, Meter ID, serial number and firmware version.

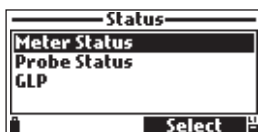

Use the arrow keys to navigate through the meter status information. Press **ESC** key to return to the menu.

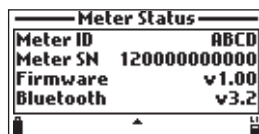
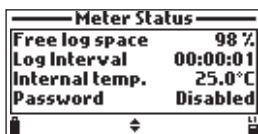
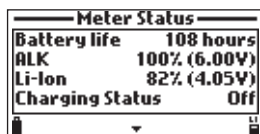

11.2. PROBE STATUS

Probe Status displays information related to the probe type, connected sensors, probe ID, serial number and firmware version.

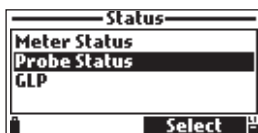

Use the arrow keys to navigate through the probe status information. Press **ESC** key to return to the menu.

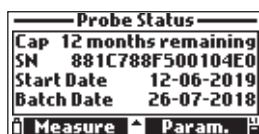
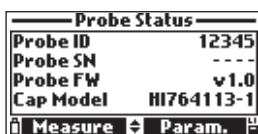
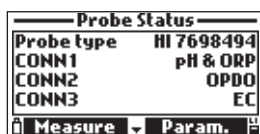

Note: The probe status screen will automatically be displayed when the probe sensor status has changed.

11.3. GLP

GLP (Good Laboratory Practice) is a set of functions that allows the user to store or recall data regarding the probe calibration. GLP data stores the last five calibrations.

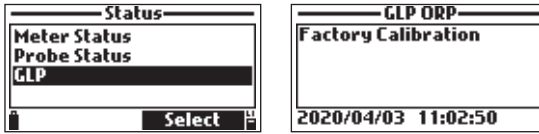

Note: If no user calibration data is available for the selected parameter, “Factory Calibration” message is displayed.

To navigate the GLP screens:

- Use the arrow keys to scroll through the stored data for the last 5 calibrations.
- Press ESC key to return to the menu.

pH

pH GLP screen displays: offset, acidic slope, basic slope, buffers used, time and date of the calibration.

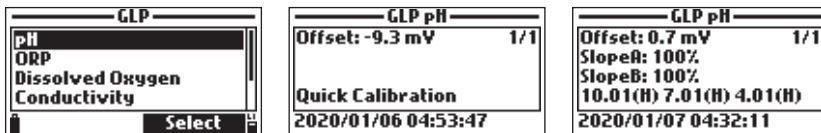

Notes: A “C” label next to the buffer value indicates a custom point, while an “H” indicates a Hanna Instruments standard buffer value.

If a quick calibration was performed, the buffer values are replaced with the “Quick Calibration”.

ORP

ORP GLP screen displays: calibration point, offset between measured and calibrated value, time and date.

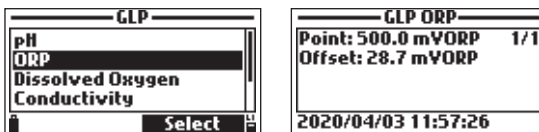

Dissolved Oxygen

DO GLP screen displays: calibration points, calibration type (% saturation or concentration), time and date.

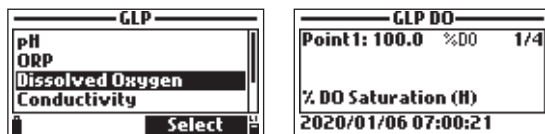

Notes: A “C” label next to the calibration point indicates a custom point, while an “H” indicates a Hanna Instruments standard value.

If a quick calibration was performed, the calibration points are replaced with the “Quick Calibration”.

Conductivity

Conductivity GLP screen displays: calibration point, cell constant value, offset, calibration type (conductivity, absolute conductivity or salinity), time and date.

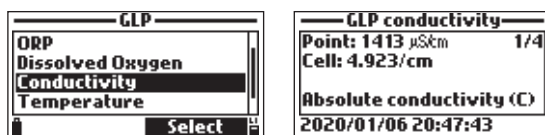

Notes: A “C” label next to the calibration point indicates a custom point, while an “H” indicates a Hanna Instruments standard value.

If a quick calibration was performed, the calibration point is replaced with the “Quick Calibration”.

Temperature

Temperature GLP screen displays: calibrated point, time and date.

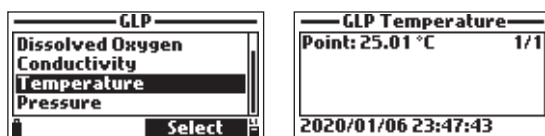

Pressure

Atmospheric pressure GLP screen displays: calibration point, time and date.

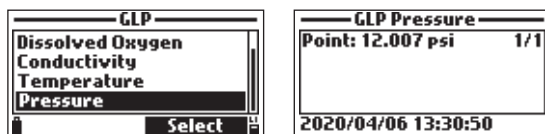

12. MEASUREMENT

During measurement mode **HI98494** will simultaneously measure data for all enabled parameters. Use the numbers 1 through 7 on the keypad to select the number of parameters that are shown on the screen at one time. The display will automatically resize the font.

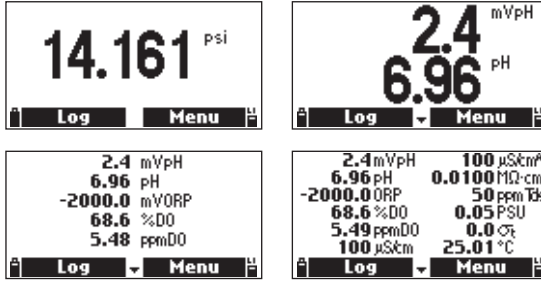

Use the arrow keys to scroll through the enabled parameters if they do not fit on one screen. A blinking measurement value indicates that the measurement is out of range.

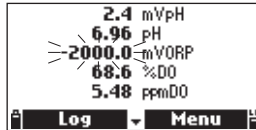

A blinking measurement unit indicates that the user calibration has not been done and is needed for accurate readings.

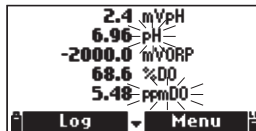

13. LOGGING

The HI98494 and the HI7698494 multi-sensor probe offer two types of logging: meter only parameters, and meter and probe parameters.

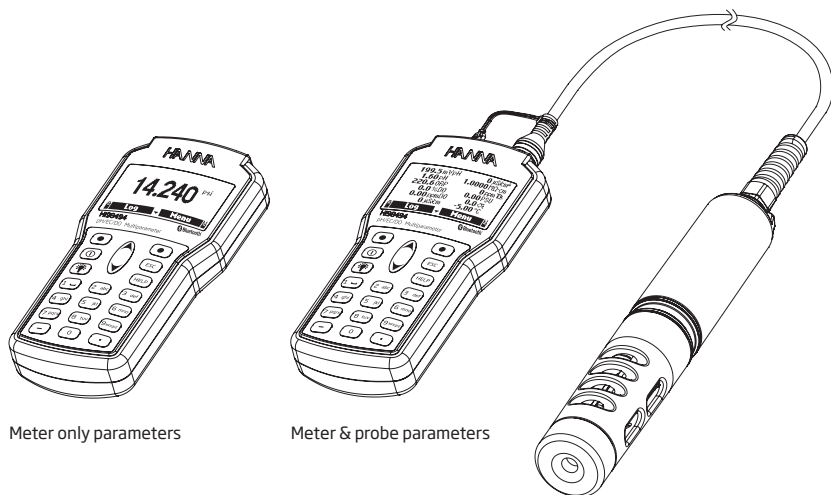

Meter only parameters

Meter & probe parameters

From measurement mode, press **Log** to access Log menu.

The data logged on the meter are organized by lots. Up to 50000 complete records can be stored in up to 100 lots. Each lot can store log-on-demand records or continuous records with different parameter configurations.

2.4mVpH	100 μ S/cm ^A
6.96 pH	0.0100 μ Ω/cm
-2000.0 ORP	50 ppm TDS
68.6 %DO	0.05 PSU
5.49 ppmDO	0.0 σ_t
100 μ S/cm	25.01 $^{\circ}$ C
Log	Menu

Note: The values displayed for DO concentration, compensated conductivity and TDS are dependent on the coefficients defined in Parameter Coefficients in Setup menu (EC Reference Temperature, EC Temperature Coefficient, TDS factor and Salinity). If parameter units or coefficients are altered, stored logs on this meter will be altered reflecting these changes. Save logs to a PC before altering parameters or coefficients. Details are available only for the enabled parameters.

13.1. ONE SAMPLE ON METER

1. Select “One sample on meter” to add one set of enabled measurement parameters to the meter’s memory.

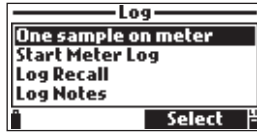

2. If there are existing lots on the meter, select the lot to log the sample in. If no lots have been saved or to create a new lot, press **New**. Use the keypad to enter desired lot name and press **Accept** to confirm.

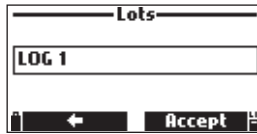

3. Press **OK** to log the sample in the selected lot.
4. The Remarks window will open, press **Yes** to add a remark to the data point or **No** to skip. The meter will return to the measurement screen automatically.



13.2. START METER LOG

1. Select “Start Meter Log” to log the enabled parameters at the set logging interval on the meter.

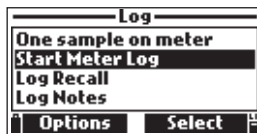

2. To set the logging interval, press **Options**. The log interval time can be set from 1 second to 3 hours. Press **Modify** and use the alphanumeric keys to enter the desired log interval. Press **Accept** to confirm.

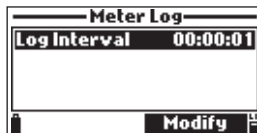

3. Press **Select** to start the logs. Use the keypad to enter desired lot name.

4. Press **Accept** to confirm.
5. The Remarks window will open, press **Yes** to add a remark to the data point or **No** to skip.

The meter will return to the measurement screen and the log will start.

To stop the meter log, press **Log** and select “*Stop Meter Log”.

To update the remarks, press **Log** and select “Log Notes”.



13.3. LOG RECALL

Select “Log Recall” to view logs that are stored on the meter.

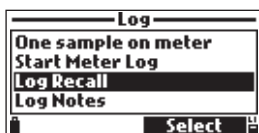

Lots

Select this option to view all continuous log files saved on the meter.



1. Use the arrow keys to select the desired lot and then press **View**. The meter displays a summary of all data related to the selected lot: number of samples, used memory space, time and date of the first and last readings.



2. Press **View** to review the log data. Use the arrow keys to change the sample number in the selected lot. The sample number is shown on the bottom right corner of the display.
3. Press **Info** to see record information for the current sample: time and date, remark or serial number (if available).
4. Press **Data** to return to the previous screen or **Jump** to select a different sample in the same lot. When **Jump** is pressed, a text box appears to insert the desired sample number.
5. Press **ESC** key to return to the menu.
6. Press **Plot**, and the meter will create a list with all available parameters that can be plotted.
7. Use the arrow keys to select the parameter to be plotted. Press **Select** to view the graph.

8. Use the arrow keys to move the cursor in the graph and highlight a sample. The sample data is displayed below the graph.
9. Press **ESC** key to return to the parameter list.

Press **Options** (from the log list screen) to Export or Delete an individual Log.

Export selected log data to USB-C Flash Drive:

1. Insert a USB-C flash drive (or USB-A with cable adapter) into the USB-C connector located on the top of meter. See section 13.5. PC CONNECTION for details.
2. Select Export Log. Connecting will be displayed followed by the file transfer information.

When all files have been transferred, "File transfer completed" message will be displayed.



Log On Demand

Select this option to view the log on demand lots and plot selected parameters.



1. Use the arrow keys to select the desired lot and then press **View**.
2. Press **View** to review the log data.

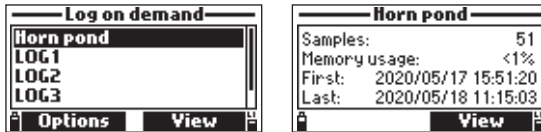

3. Press **Info** to see record information for the current sample: time and date, remark or serial number.

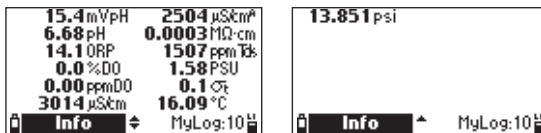

4. Press **Data** to return to the previous screen or **Jump** to select a different sample in the same lot. When **Jump** is pressed, a text box appears to insert the desired sample number.

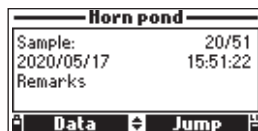

5. Press **ESC** key to return to the menu.
6. Press **Plot**, and the meter will create a list with all available parameters that can be plotted.
7. Use the arrow keys to select the parameter to be plotted. Press **Select** to view the graph.

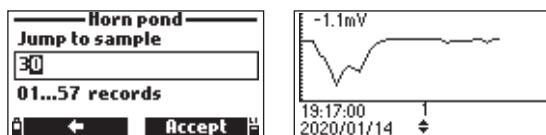

8. Use the arrow keys to move the cursor in the graph and highlight a sample. The sample data is displayed below the graph.
9. Press **ESC** key to return to the parameter list.

Note: The number of lot samples that can be plotted is limited by the display resolution. To view a complete graph download data to PC.

Export All Logs

Select this option to export all logs to a PC.



Export all logged data to USB-C Flash Drive:

1. Insert a USB-C flash drive (or USB-A with cable adapter) into the USB-C connector located on the top of meter. See section 13.5. PC CONNECTION for details to transfer files to a PC directly.
2. Select Export All Logs

Connecting will be displayed followed by the file transfer information.

When all files have been transferd, "File transfer completed" message will be displayed.

Delete All Logs

When this option is selected the instrument will ask for confirmation.

Press **Yes** to delete or **No** to return to the previous screen.

To return to the "Log Recall" menu, press **ESC** key.



13.4. LOG NOTES

Remarks

The meter can store up to 20 remarks. A remark can be associated with each sample.

To add a remark:

1. Select “Log Notes” from the Log menu, and then select “Remarks”. The display shows a list of stored remarks.



2. Press **New** to create a new remark, and use the keypad to enter the new remark in the text box.
3. Press **Delete** to delete the selected remark from the meter. If the deleted remark is used in an existing lot, the information will be still available in the lot data.

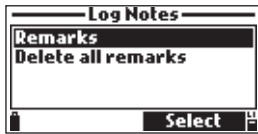

Delete All Remarks

When this option is selected the instrument will ask for confirmation: “Do you want to perform the current operation?”.

Press **Yes** to delete or **No** to return to the previous screen.

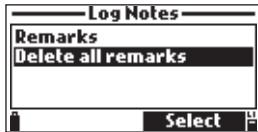

13.5. PC CONNECTION

The logged data from a probe and meter can be transferred to a PC.

- Use the USB A to C cable to connect the meter to the PC.
- The meter will appear as a flash drive on the computer.
- Save files to the PC. All logs will be listed as CSV files (comma separated values).

The CSV files may be opened with any text editor or spreadsheet application.

All features of the spreadsheet program can be used to analyze and graph the data.

14. PROBE DEPLOYMENT

The Hanna Instruments [HI7698494](#) multi-sensor probe has been designed for a variety of water quality measurements both in situ or in active deployments in urban or natural waters. Data quality is dependent upon the site location, service intervals, amount of coatings, sedimentation and vegetation, and the actual installation.

The deployment location must be accessible for the duration of the measurement (consider seasonal flooding, freezing and other acts of nature) when selecting a site.

The probe may be installed in a horizontal bank (fixed installation) or a vertical suspension (maximum depth of 20 m). Unlike probes that require a cable support for active deployments the probe can be manually lowered and raised by the cable due to its superior strength.

To protect the equipment avoid exposure to wind, sun, foam, turbulence, air temperature gradients, extended periods of high flow, extended periods of high sediment and floating debris.

The probe is suitable for installation in:

- Confined locations such as air vaults, river intakes, vertical wells, tanks
- Open moving waters locations such as rivers, streams, ditches (farmland drainage), conveyance canals
- Open waters locations such as lakes, ponds, wetland basin, infiltration basins, bays
- A flow cell

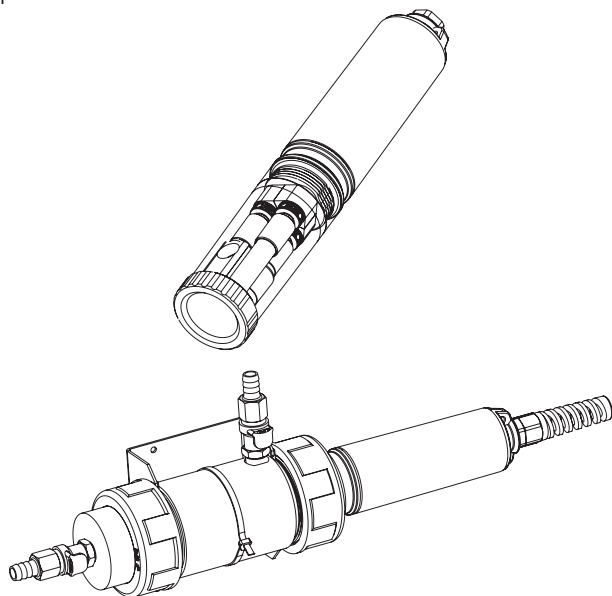

During long deployments, the instrument can be secured by the metallic eyelet at the top.

Guidelines for Installation & Sampling Site Maintenance

- Select a water-sampling site that will allow collection of representative water samples.
- Position the probe so the sensor surfaces face toward the flow, this will minimize air bubble or fluid cavitation. Limit flow rate to moderate.
- Mount the probe at a 0 to 45° angle. This will prevent the pH (pH/ORP) sensor from becoming electrically discontinuous due to internal electrolytes flowing away from their internal cells.
- Ensure sampling sites have easy access.
- Regularly visit water sampling sites to check for damage to sensors, the installation mountings, and the meter battery power.
- Remove aquatic weed growth that may be interfering with water sample collection.
- Position suspended probes behind a support and anchor the cable/probe to a pipe to protect against debris.
- Have access to spare sensors and calibration standards or buffers.
- Strictly follow the established standard operating procedures (SOPs).
- Avoid trapped air and maintain constant flow rate if installed in a flow cell.

15. TROUBLESHOOTING & ERROR MESSAGES

HI98494 displays error messages to aid in troubleshooting. Warnings are displayed for non-critical issues, while errors are displayed for critical issues.

See section 8. CALIBRATION for warning and error messages during calibration.

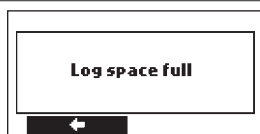

“Log space full” is displayed when the meter memory is full and additional data cannot be logged. Delete one or more lots from the meter.



“Power fault. Check the probe cable” is displayed when powering up the meter with a probe connected. It is triggered if the meter detects a high load on the probe connection. Check the probe cable. If the problem persists, contact your local Hanna Instruments Office.



“Language data not available!” is displayed when powering up the meter if the language file is not loaded. Restart the meter. If the problem persists, contact your local Hanna Instruments Office.



“Dead meter battery!” is displayed if the meter batteries are too low to power the meter. The meter will automatically turn off. Connect the charger if using rechargeable battery or replace the alkaline batteries to continue.



“User data corrupted!” is displayed when powering up and the user data stored on meter are corrupted. Restart the meter. If the problem persists, contact your local Hanna Instruments Office.

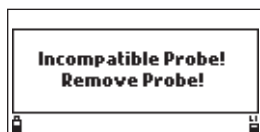

“Incompatible Probe” is displayed when the connected probe is not compatible with the meter. Replace the probe.

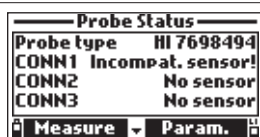

“Incompat.sensor!” is displayed when the connected sensor is not compatible with probe or meter. Replace the sensor before continuing.

Probe Status	
Probe type	HI 7698494
CONN1	No sensor
CONN2	No sensor
CONN3	Wrong input
Measure Param.	

“Wrong input” is displayed when the connected sensor is not compatible with the connector.
Replace the sensor before continuing.

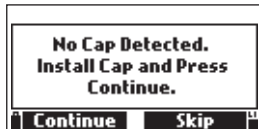

“No Cap Detected” is displayed when the cap on the dissolved sensor is not inserted properly.
Check and / or reseat the cap then press **Continue**. Press **Skip** to continue without the opdo[®] sensor.



“No Cap Info Detected” is displayed during initialization when the cap information cannot be read.
Check the cap, press **Continue** and retry. Press **Skip** to continue without the opdo[®] sensor. If the problem persists, replace the cap.



“Cap Info Error” is displayed when the sensor is damaged.
Reseat the cap and press **Continue**. Press **Skip** to continue without the opdo[®] sensor. If the problem persists, replace the cap.



“Cap Expired” is displayed when the cap has expired.
Press **Continue** or replace the cap. Continued use may result in incorrect measurements. Press **Skip** to continue without the opdo[®] sensor.

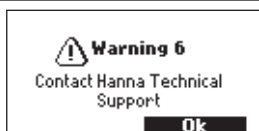

“Warning xxx”



Warnings displayed at power-on are identified using a numeric code.



Restart the meter. If the problem persists, contact your local Hanna Instruments Office. Some features can be accessed but with no guarantee.

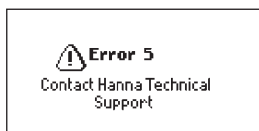

“Error x”

Critical errors are identified using a numeric code, and the meter is automatically switched off.
Contact your local Hanna Instruments Office.

16. ACCESSORIES

PROBES (supplied without sensors or protective shield)

Code	Description
HI7698494/4	Probe with 4 m (13.1') cable
HI7698494/10	Probe with 10 m (33.0') cable
HI7698494/20	Probe with 20 m (65.6') cable
HI7698494/40	Probe with 40 m (131.2') cable

Note: Probes with different cable lengths are available upon request.

METERS WITH PROBES & SENSORS

Code	Description
HI98494	HI98494 meter, probe with 4 m (13.1') cable, with pH/ORP, EC, optical DO sensors
HI98494/10	HI98494 meter, probe with 10 m (33.0') cable, with pH/ORP, EC, optical DO sensors
HI98494/20	HI98494 meter, probe with 20 m (65.6') cable, with pH/ORP, EC, optical DO sensors
HI98494/40	HI98494 meter, probe with 40 m (131.2') cable, with pH/ORP, EC, optical DO sensors

SENSORS

Code	Description
HI7698194-0	pH sensor
HI7698194-1	pH/ORP sensor
HI7698194-3	EC sensor
HI7698494-5	Optical DO sensor
HI764113-1	DO Smart Cap with o-ring

QUICK CALIBRATION SOLUTIONS

Code	Description
HI9828-20	Quick calibration solution, 230 mL
HI9828-25	Quick calibration solution, 500 mL
HI9828-27	Quick calibration solution, 1 gallon

pH BUFFERS

Code	Description
HI5004	pH 4.01 buffer solution, 500 mL
HI5068	pH 6.86 buffer solution, 500 mL
HI5007	pH 7.01 buffer solution, 500 mL
HI5091	pH 9.18 buffer solution, 500 mL
HI5010	pH 10.01 buffer solution, 500 mL

pH / ORP MAINTENANCE SOLUTIONS

Code	Description
HI70670L	pH/ORP cleaning solution for salt deposits, 500 mL
HI70671L	pH/ORP cleaning and disinfecting solution for algae, fungi and bacteria, 500 mL
HI70300L	pH/ORP electrode storage solution, 500 mL

ORP STANDARDS

Code	Description
HI7021L	ORP test solution, 240 mV @ 25 °C, 500 mL
HI7022L	ORP test solution, 470 mV @ 25 °C, 500 mL

DO SOLUTION

Code	Description
HI7040L	Zero oxygen solution set, 500 mL + 12 g

CONDUCTIVITY STANDARD SOLUTIONS

Code	Description
HI7030L	12880 $\mu\text{S}/\text{cm}$ calibration solution, 500 mL
HI7031L	1413 $\mu\text{S}/\text{cm}$ calibration solution, 500 mL
HI7033L	84 $\mu\text{S}/\text{cm}$ calibration solution, 500 mL
HI7034L	80000 $\mu\text{S}/\text{cm}$ calibration solution, 500 mL
HI7035L	111800 $\mu\text{S}/\text{cm}$ calibration solution, 500 mL
HI7039L	5000 $\mu\text{S}/\text{cm}$ calibration solution, 500 mL

OTHER

Code	Description
HI7698290	Short calibration beaker
HI7698295	Short protective shield
HI7698297	Long, quick release flow cell
HI76984942	Probe maintenance kit with small brush, small hex key, o-rings for probe and grease to lubricate the o-rings, lens cleaning wipe
HI920016	USB type A to C cable
HI710034	Orange protective rubber boot for meter

CERTIFICATION

All Hanna Instruments conform to the CE European Directives.



Disposal of Electrical & Electronic Equipment. The product should not be treated as household waste. Instead hand it over to the appropriate collection point for the recycling of electrical and electronic equipment which will conserve natural resources.

Disposal of waste batteries. This product contains batteries, do not dispose of them with other household waste. Hand them over to the appropriate collection point for recycling.

Ensuring proper product and battery disposal prevents potential negative consequences for the environment and human health. For more information, contact your city, your local household waste disposal service, the place of purchase or go to www.hannainst.com.



RECOMMENDATIONS FOR USERS

Before using this product, make sure it is entirely suitable for your specific application and for the environment in which it is used. Any variation introduced by the user to the supplied equipment may degrade the meter's performance. For your and the meter's safety do not use or store the meter in hazardous environments.

WARRANTY

The HI98494 is warranted for two years (sensors, electrodes and probes for six months) against defects in workmanship and materials when used for its intended purpose and maintained according to instructions. This warranty is limited to repair or replacement free of charge. Damage due to accidents, misuse, tampering or lack of prescribed maintenance is not covered.

If service is required, contact your local Hanna Instruments Office. If under warranty, report the model number, date of purchase, serial number (engraved on the bottom of the meter) and the nature of the problem. If the repair is not covered by the warranty, you will be notified of the charges incurred. If the instrument is to be returned to Hanna Instruments, first obtain a Returned Goods Authorization (RGA) number from the Technical Service department and then send it with shipping costs prepaid. When shipping any instrument, make sure it is properly packed for complete protection.

Hanna Instruments reserves the right to modify the design, construction or appearance of its products without advance notice.

World Headquarters

Hanna Instruments Inc.
Highland Industrial Park
584 Park East Drive
Woonsocket, RI 02895 USA
www.hannainst.com



MAN98494

Printed in ROMANIA